

# SERVICE MANUAL

## SINGLE SKIN UNDERCOUNTER DISHWASHER



## DOUBLE SKIN UNDERCOUNTER DISHWASHER



**Document made by Product Care - Technical Training & Service - Vallenoncello PN/Italy**

All the images and information of this document are property of ©Electrolux Professional Spa.

This document and all of its contents cannot be copied or used, in part or entirely without the written authorization of Electrolux Professional Spa.

©Electrolux Professional Spa. All rights reserved.

## REVISIONS UPDATE

EDITION	DESCRIPTION	DATE
01	First publication of this manual	<b>February 2021</b>
02	Add description USPH5 for model 502744 (AV.TO 7803)	<b>March 2021</b>

## FOREWARD



The service manual (here in after Manual) provides the engineer with information necessary for correct and safe use of the machine (or “appliance“, “machine” or “unit”).

The following must not be considered a long and exacting list of warnings, but rather a set of instructions suitable for improving machine performance in every respect and, above all, preventing injury to persons and animals and damage to property due to improper operating procedures.

All persons involved in machine transport, installation, commissioning, use and maintenance, repair and disassembly must consult and carefully read this manual before carrying out the various operations, in order to avoid wrong and improper actions that could compromise the machine's integrity or endanger people.

If, after reading this manual, there are still doubts regarding machine use, do not hesitate to contact the Manufacturer or the Customer Care to receive prompt and precise assistance for better operation and maximum efficiency of the machine. During all stages of machine assessment, always respect the current regulations on safety, work hygiene and environmental protection. It is the user's responsibility to make sure the machine is started and operated only in optimum conditions of safety for people, animals and property.

## IMPORTANT



- The manufacturer declines any liability for operations carried out on the appliance without respecting the instructions given in this manual.
- The manufacturer reserves the right to modify the appliances presented in this publication without notice.
- No part of this manual may be reproduced without the consent of the manufacturer.
- This manual is available in digital format by:
  - contacting the dealer or reference customer care;
  - downloading the latest and up to date manual/technical bulletin(s) available on the web site: <https://www.electroluxprofessional.com> and <https://webgate.electroluxprofessional.com>

**The manual must always be part of the documentation available when servicing the machine.**

## MODELS COVERED BY THE SERVICE MANUAL

Please, for the detailed list of models covered by this Service Manual refer to the Programming parameters manual available on website <https://www.electroluxprofessional.com> and <https://webgate.electroluxprofessional.com>.

# INDEX

<b>1</b>	<b>INTRODUCTION</b>	<b>8</b>
1.1	GENERAL INFORMATION	8
1.2	SAFETY INFORMATION/PRECAUTIONS	9
1.2.1	Personal protection equipment	10
1.2.2	General information	10
1.2.3	Residual risks	11
1.3	DATA PLATE (IDENTIFICATION STICKER)	13
1.3.1	Machine and manufacturer's identification data	13
1.3.2	Additional indications	14
1.3.3	How to interpret the acronym on dataplate	14
1.3.4	How to interpret the serial number	15
1.3.5	Responsibility	15
1.3.6	Copyright	15
1.3.7	Recipients of the manual	15
1.4	EQUIPMENT DESCRIPTION	16
1.4.1	Overall drawings with measurements	16
1.4.2	Main technical data	17
<b>2</b>	<b>INSTALLATION AND COMMISSIONING</b>	<b>21</b>
2.1	INSTALLATION	21
2.2	COMMISSIONING	21
2.2.1	Function check	21
2.2.2	Basic operation to test the machine	22
<b>3</b>	<b>USE OF APPLIANCE</b>	<b>23</b>
3.1	OPERATING INSTRUCTIONS	23
3.2	PREVENTIVE ROUTINES/MAINTENANCE FOR THE OPERATOR	23
3.3	PREVENTIVE MAINTENANCE PLAN (FOR SERVICE)	23
3.3.1	Peristaltic tube fitting and replacement instructions	23
<b>4</b>	<b>DETAILED APPLIANCE AND COMPONENTS DESCRIPTION/FUNCTIONING</b>	<b>25</b>
4.1	CONTROL PANEL	25
4.2	SETTING MODES	25
4.3	MANUAL ACTIVATION OF DETERGENT AND RINSE AID DISPENSERS	26
4.4	RINSE PUMP MANUAL ACTIVATION	26
4.5	PARAMETERS TREE	26
4.5.1	ON/OFF + Cycle1 keys	26
4.5.2	ON/OFF + Cycle 2 keys	27
4.6	DETERGENT AND RINSE AID DOSAGE	28
4.7	<sup>(*)</sup> NOTE FOR EXTERNAL DISPENSER	29
4.8	COUNTERS	30
4.9	 COUNTERS	30
4.10	TEMPERATURE SETTING	31
4.11	CYCLES SETTING	32
4.12	CYCLE DIAGRAM	32
4.13	 – CYCLE 1 PARAMETERS	33

# SERVICE MANUAL

4.14	ЦУ2 – CYCLE 2 PARAMETERS .....	33
4.15	ЦУ3 – CYCLE 3 PARAMETERS .....	33
4.16	дрн – DRAIN/CLEANING CYCLE PARAMETERS .....	34
4.17	дРР – DISHWASHING PARAMETERS.....	34
4.18	рон – READ ONLY PARAMETERS.....	35
4.19	МСП – COMMUNICATION AND HACCP PARAMETERS .....	35
4.20	ЦФУ – CONFIGURATION PARAMETERS .....	35
4.21	RESIN REGENERATION CYCLE.....	37
4.22	MEDICAL LINE DISHWASHER WITH DOOR LOCK DEVICE.....	37
4.23	DETERGENT AND RINSE AID LEVEL SENSORS ACTIVATION.....	37
4.24	DISHWASHER WITH INCORPORATED CONTINUOUS WATER SOFTENER .....	37
<b>5</b>	<b>TROUBLESHOOTING.....</b>	<b>39</b>
5.1	GENERAL TROUBLESHOOTING .....	39
5.2	TROUBLESHOOTING BY CODED ANOMALIES LIST.....	43
<b>6</b>	<b>SERVICING THE APPLIANCE .....</b>	<b>49</b>
6.1	LIST OF NEEDED TOOLS .....	49
6.1.1	Ordinary tools.....	49
6.1.2	Special tools.....	49
6.2	COMPONENTS REPLACEMENT – SINGLE SKIN UNDERCOUNTER .....	49
6.2.1	Components layout for single skin undercounter.....	50
6.2.2	Door B1 replacement.....	51
6.2.3	Access to front components.....	51
6.2.4	Main board B2 replacement.....	52
6.2.5	Salt container B3 replacement.....	52
6.2.6	Boiler heating element B4 replacement .....	53
6.2.7	Boiler temperature sensor B5 replacement.....	54
6.2.8	Tank heating element B6 replacement.....	54
6.2.9	Access to back components .....	55
6.2.10	Boiler B7 replacement .....	56
6.2.11	Tank temperature sensor B8 replacement.....	57
6.2.12	Clixson tank heating element B9 replacement .....	58
6.2.13	Wash pump B10 replacement.....	59
6.2.14	Drain manifold tank B11 replacement .....	61
6.2.15	Rinse pump B12 replacement.....	63
6.2.16	Loading solenoid valve B13 replacement.....	64
6.2.17	Lower Jet support B14 replacement .....	66
6.2.18	Air gap B15 replacement .....	68
6.2.19	Water softener B16 replacement .....	69
6.2.20	Rinse aid pump B17 replacement.....	71
6.2.21	Pressure switch B18 replacement.....	72
6.2.22	User interface B19 replacement .....	73
6.2.23	Door micro switch B20 replacement .....	74
6.3	COMPONENTS REPLACEMENT - DOUBLE SKIN UNDERCOUNTER .....	75
6.3.1	Components layout double skin undercounter .....	75
6.3.2	Door C1 replacement .....	76

6.3.3	Access to front components.....	76
6.3.4	Main board C2 replacement.....	77
6.3.5	Water softener C16 and salt container C3 replacement.....	77
6.3.6	Boiler heating element C4 replacement.....	79
6.3.7	Boiler temperature sensor C5 replacement.....	80
6.3.8	Tank heating element C6 replacement.....	80
6.3.9	Access to back components.....	81
6.3.10	Boiler C7 replacement.....	82
6.3.11	Tank temperature sensor C8 replacement.....	83
6.3.12	Clixson tank heating element C9.....	84
6.3.13	Wash pump C10 replacement.....	85
6.3.14	Drain manifold tank C11 replacement.....	86
6.3.15	Rinse pump C12 replacement.....	88
6.3.16	Loading solenoid valve C13 replacement.....	88
6.3.17	Drain pump C14 replacement.....	89
6.3.18	Detergent pump C15 and rinse aid pump C 17 replacement.....	90
6.3.19	Tank Pressure switch C18 replacement.....	90
6.3.20	User interface C19 replacement.....	91
6.3.21	Door Switch C20 replacement.....	91
<b>7</b>	<b>RELATED DOCUMENTS.....</b>	<b>92</b>
7.1	EXPLODED VIEW.....	92
7.2	ELECTRICAL WIRING DIAGRAM.....	92
7.3	PLUMBING CIRCUITS DIAGRAMS.....	92
7.3.1	Undercounter with pressure boiler without drain pump.....	92
7.3.2	Undercounter with pressure boiler and drain pump.....	92
7.3.3	Undercounter with atmospheric boiler.....	93
7.4	PROGRAMMING PARAMETERS.....	93

## 1 INTRODUCTION

---

### 1.1 GENERAL INFORMATION

To ensure safe use of the machine and a proper understanding of the manual it is necessary to be familiar with the terms and typographical conventions used in the documentation. The following symbols are used in the manual to indicate and identify the various types of hazards:

**WARNING**

Danger for the health and safety of operators.

**WARNING**

Danger of electrocution - dangerous voltage.

**CAUTION**

Risk of damage to the machine or the product.

**WARNING**

Danger of magnetic fields.

**IMPORTANT**

Important instructions or information on the product.



Read the instructions before using the appliance.



Clarifications and explanations

- Only specialized personnel are authorized to operate on the machine.
- This appliance must not be used by minors and adults with limited physical, sensory or mental abilities or without adequate experience and knowledge regarding its use.
  - Do not let children play with the appliance.
  - Keep all packaging and detergents away from children.
  - Cleaning and user maintenance shall not be made by children without supervision.
- Do not store explosive substances, such as pressurized containers with flammable propellant, in this appliance or close to the appliance.



## 1.2 SAFETY INFORMATION/PRECAUTIONS



**DANGER!** The tasks described in this manual are reserved to specialize personnel, authorized by the Manufacturer who must work while respecting the rules in force in the country of use and the rules as regards facilities and safety AT WORK.



**DANGER!** Carefully read all the instructions contained in this manual and in the installation and use manual before every intervention.



**DANGER!** This manual should be carefully preserved for future reference.



**DANGER!** Always work in perfect physical condition and provided with personal protective tools (e.g. Safety shoes, gloves, glasses etc...).



**DANGER!** When working the equipment, make sure in the work area are not present unauthorized persons, flammable or explosive materials and objects that could hinder operations.



**DANGER!** Before doing any work on the equipment ALWAYS unplug it from the power supply (danger of fatal electric shock!).



**DANGER!** If parts have been replaced, do not leave unattended their packaging (e.g. Plastic bags): choking hazard to children and animals. Packaging must be di- sposed according to local regulations.



**DANGER!** Interventions, tampering or not expressly authorized changes that do not comply with the instructions in this manual may cause damage, injury or death and will void the warranty



**DANGER!** When working on the equipment maintain good ventilation in the room.



**DANGER!** After the intervention, before operating the equipment:  
Make sure to have reassembled correctly all the pieces and any previously disassembled safety devices.  
Make sure you have correctly connected the device to the mains.  
Instruct the operator on any possible new device on the machine.







**DANGER!** The surfaces become hot during use and remain hot for some time after the equipment has been switched off: any maintenance is therefore to be executed after the equipment has been fully cooled.



**WARNING!** Some parts have sharp inner edges: always use gloves.

## 1.2.1 Personal protection equipment

Summary table of the Personal Protection Equipment (PPE) to be used during the various stages of the machine's service life.

Stage	Protective garments 	Safety footwear 	Gloves 	Glasses 	Safety helmet 
Transport	—	●	○	—	○
Handling	●	●	○	—	—
Unpacking	○	●	○	—	—
Installation	○	●	● <sup>1</sup>	—	—
Normal use	●	●	● <sup>2</sup>	○	—
Adjustments	○	●	—	—	—
Routine cleaning	○	●	● <sup>1,3</sup>	○	—
Extraordinary cleaning	○	●	● <sup>1,3</sup>	○	—
Maintenance	○	●	○	—	—
Dismantling	○	●	○	○	—
Scrapping	○	●	○	○	—
<b>Key:</b>					
●	PPE REQUIRED				
○	PPE AVAILABLE OR TO BE USED IF NECESSARY				
—	PPE NOT REQUIRED				

1. During these operations, gloves must be cut-resistant. Failure to use the personal protection equipment by operators, specialized personnel or users can involve exposure to damage to health (depending on the model).
2. During these operations, gloves must be heatproof and suitable for contact with water and the substances used (refer to the safety data sheet of the substances used for the information regarding the required PPE). Failure to use the personal protection equipment by operators, specialized personnel or users can involve exposure to chemical risk and cause possible damage to health (depending on the model).
3. During these operations, gloves must be suitable for contact with chemical substances used (refer to the safety data sheet of the substances used for information regarding the required PPE). Failure to use the personal protection equipment by operators, specialized personnel or users can involve exposure to chemical risk and cause possible damage to health (depending on the model).

## 1.2.2 General information

- The machines are provided with electric and/or mechanical safety devices for protecting workers and the machine itself. Therefore the user must not remove or tamper with such devices. The Manufacturer declines any liability for damage due to tampering or their non-use.
- Never operate the machine, removing, modifying or tampering with the guards, protection or safety devices.
- Do not make any modifications to the parts supplied with the appliance.
- Several illustrations in the manual show the machine, or parts of it, without guards or with guards removed. This is purely for explanatory purposes. Do not use the machine without the guards or with the protection devices deactivated.
- Do not remove, tamper with or make illegible the safety, danger and instruction signs and labels on the machine.
- Inadequate ventilation causes asphyxia. Do not obstruct the ventilation system in the place where this appliance is installed. Do not obstruct the vents or ducts of this or other appliances.
- Place emergency telephone numbers in a visible position.
- The measured sound level emitted "A" does not exceed 70 dB ("A").
- Turn the appliance off in case of fault or poor operation.
- Do not use products (even if diluted) containing chlorine (sodium hypochlorite, hydrochloric or muriatic acid, etc.) to clean the appliance or the floor under it.
- Do not use metal tools to clean steel parts (wire brushes or Scotch Brite type scouring pads).
- Do not allow oil or grease to come into contact with plastic parts. Do not allow dirt, fat, food or other residuals to form deposits on the appliance.
- Do not spray water or use steam to clean the equipment.
- Do not store or use gasoline or other flammable vapors, liquids or items in the vicinity of this or any other appliance.

- Do not spray aerosols in the vicinity of this appliance while it is in operation.
- Never check for leaks with an open flame.

### 1.2.3 Residual risks

The machine has several risks that were not completely eliminated from a design standpoint or with the installation of adequate protection devices. Nevertheless, through this manual the Manufacturer has taken steps to inform operators of such risks, carefully indicating the personal protection equipment to be used by them. Sufficient spaces are provided for during the machine installation stages in order to limit these risks.

To preserve these conditions, the areas around the machine must always be:

- kept free of obstacles (e.g. ladders, tools, containers, boxes, etc.);
- clean and dry;
- well lit.

For the Customer's complete information, the residual risks remaining on the machine are indicated below: such actions are deemed improper and therefore strictly forbidden.

Residual risk	Description of hazardous situation
Slipping or falling	The operator can slip due to water or dirt on the floor
Burns/abrasions (e.g. heating elements)	The operator deliberately or unintentionally touches some components inside the machine without using protective gloves
Electrocution	Contact with live parts during maintenance operations carried out with the electrical panel powered
Sudden closing of the lid/ door/oven door (if present, depending on the appliance type)	The operator for normal machine use could suddenly and deliberately close the lid/door/oven door (if present, depending on the appliance type)
Tipping of loads	When handling the machine or the packing containing it, using unsuitable lifting systems or accessories or with the load unbalanced.





#### Mechanical safety characteristics, hazards





- The appliance does not have sharp edges or protruding parts. The guards for the moving and live parts are fixed to the cabinet with screws, to prevent accidental access.

#### Protection devices installed on the machine

- The guards on the machine are:
  - fixed guards (e.g. casings, covers, side panels, etc.), fixed to the machine and/or frame with screws or quick-release connectors that can only be removed or opened with tools.

## Safety signs to be placed near the machine area

Prohibition	Meaning
	Do not remove the safety devices.
	Do not use water to extinguish fires (placed on electrical parts).
	Keep the area around the appliance clear and free from combustible materials. Do not keep flammable materials in the vicinity of the appliance.
	Install the appliance in a well-ventilated place to avoid the creation of dangerous mixtures of unburnt gases in the same room.

Danger	Meaning
	Danger of burns.
	Danger of electrocution (shown on electrical parts with indication of voltage).
	Risk of electromagnetic fields.
	Access forbidden to wearers of electrical stimulator (pacemakers).

### End of use

- When the appliance is no longer to be used, make it unusable by removing the mains power supply wiring.

### 1.3 DATA PLATE (IDENTIFICATION STICKER)

#### 1.3.1 Machine and manufacturer's identification data

An example of the marking or data plate on the machine is given below:

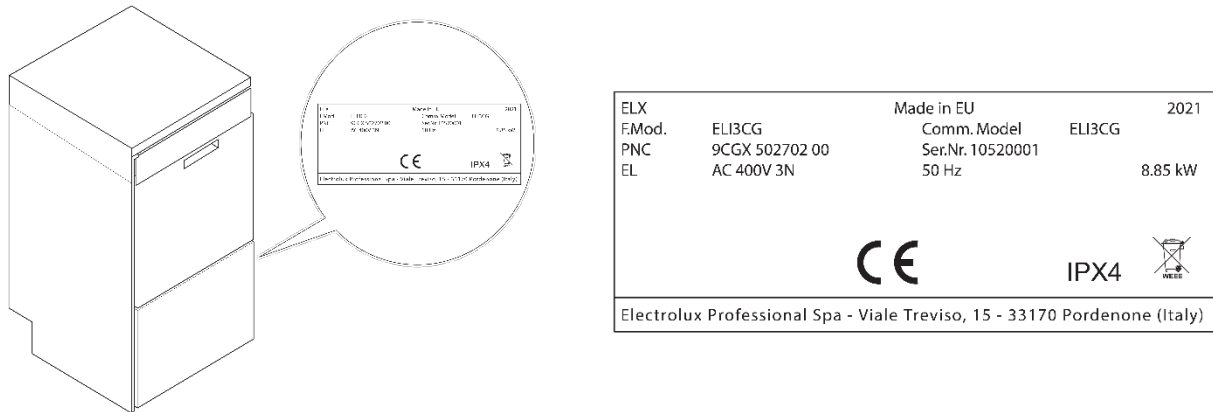

**WARNING!** Do not remove or modify the machine's markings or cause them to be difficult to read.



**IMPORTANT!** Please review the relationship with the manufacturers from the data on the machine markings (e.g. when ordering spare parts).



**IMPORTANT!** When the machine is scrapped, the markings must be destroyed.

The data plate gives the product identification and technical data. The meaning of the various information given on it is listed below:

F.Mod.	Factory description of product
Type	List of acronyms used to identify the type of machine, uniquely
PNC	Production number code
IPX4	Dust and water protection rating
Comm.Model	Commercial description
Serial Number	Serial number
EL:	Power supply voltage
Hz	Power supply frequency
KW	Max. power input



**IMPORTANT:** When installing the machine, make sure the electrical connection is carried out in compliance with that specified on the data plate.



**NOTE!** Refer to the data given on the machine's data plate for relations with the Manufacturer (e.g. when ordering spare parts, etc.).

## 1.3.2 Additional indications

The drawings and diagrams given in the manual are not in scale. They supplement the written information with an outline, but are not intended to be a detailed representation of the machine supplied. The numerical values given on the machine installation diagrams refer to measurements in millimeters and/or inches.

## 1.3.3 How to interpret the acronym on dataplate

The factory model description on the data plate has the following meaning (some examples are given below):

(1)	(2)	(3)	(4)	(5)	(6)	(7)	(8)
E	L	A	-	3	G	-	-
N	L	-	-	1	P	-	-
E	L	A	I	3	G	TL	-
Z	L	-	I	3	CD	-	-
V	L	A	I	1	G	-	4
E	UC	-	-	-	-	A060	-

### Variable description

(1)	Brand	E = Electrolux Professional Z = Zanussi V = Veetsan/ Veetsan Star N = Neutral to brand C = Caterwash X = KxT
(2)	Dimension	L = 500x500mm racks UC = Undercounter
(3)	Boiler type	A = Atmospheric boiler (Wash-safe for Electrolux, Active for Zanussi) - = Pressure
(4)	Machine structure	I = Double skin - = Single skin
(5)	Voltage	1 = 1 phase (standard 220-240V/ 1N/ 50Hz) 3 = 3 phase (380-415V/ 3N/ 50Hz)
(6)	Other features	C = Cold rinse D = Detergent dispenser P = Drain Pump G = Plug-in (drain pump, detergent dispenser) B = Rinse Booster pump W = Water softener U = UK plug MS = Multi rack Support L = 316L boiler OW = On Wheels NR = No Rack included
(7)	Specific range	CL = Cafe Line WL = Wine Line ML = Medical Line TL = Thermal Label compliant AG = AutoGrill MCD = Mc Donalds PR = PRomotion code A060 = Medical Line A0-60
(8)	Alternative Voltage	6 = 60Hz 4 = 240V (North America) 8 = 208V (North America) 5M = 400V/ 3/ 50Hz Marine 35M = 230V/ 3/ 50Hz Marine 6M = 440V/ 3/ 60Hz Marine 36M = 230V/ 1N/ 60Hz Marine USPH5 = USPH 400V/ 3/ 50Hz Marine USPH6 = USPH 440V/ 3/ 60Hz Marine

## 1.3.4 How to interpret the serial number

The Serial Number on the data plate uniquely identifies:

- The year of construction of the appliance;
- The week of construction of the appliance;
- The progressive number of construction.

**Example:** Serial Number **10820002**

<b>1</b>	4 <sup>th</sup> digit of the year of construction
<b>04</b>	Week of construction
<b>2</b>	3 <sup>th</sup> digit of the year of construction
<b>0002</b>	construction sequential number

In this case, the appliance is the second (**0002**) machine built in week **04** of the year **2021**.

**The Serial Number is necessary to find the correct spare part in the spare parts catalogue and it is mandatory to ask technical support from the Manufacturer.**

## 1.3.5 Responsibility

The Manufacturer declines any liability for damage and malfunctioning caused by:

- non-compliance with the instructions contained in this manual;
- repairs not carried out in a workmanlike fashion, and replacements with parts different from those specified in the spare parts catalogue (the fitting and use of non-original spare parts and accessories can negatively affect machine operation and invalidates the warranty);
- operations by non-specialised technicians;
- unauthorised modifications or operations;
- inadequate maintenance;
- improper machine use;
- unforeseeable extraordinary events;
- use of the machine by uninformed and untrained personnel.

## 1.3.6 Copyright

This manual is intended solely for consultation by the operator and can only be given to third parties with the permission of Electrolux Professional SpA.

## 1.3.7 Recipients of the manual

This manual is intended for:

- specialised technicians and after-sales service.

## 1.4 EQUIPMENT DESCRIPTION

The dishwasher is an undercounter type with hot water rinsing for rack dimension of 500x500mm.

The dishwasher is suitable for washing glasses, cups, cutlery. Under no circumstances it can be used for other applications or ways not provided for in this manual.

This equipment has been created in order to ensure a better work environment and cost efficiency.

These dishwashers are used in restaurants, cafeterias, cooking centers and large institutions. The special dishracks, that can be equipped with various inserts, offer practical and easy use for obtaining excellent washing results.

The built-in boiler is designed to raise incoming water to a guaranteed minimum temperature of 82°C for sanitizing rinse. No external boiler is required. Some models are equipped with a dedicated function for cold rinsing beer and wine glasses to cool them enough to handle after the standard cycle. Washing system is endowed with rotating washing arms from both top and bottom; high powered wash pump and large capacity wash tank guarantee professional washing.

**Tab. 1 – Connections**

Water inlet		Ø	3/4" G
Recommended water pressure [Model equipped with atmospheric boiler]		bar	2.0 - 3.0 [0.5 - 7.0]
Drain pipe [De.]	without drain pump	mm	22
	with drain pump	mm	27
Electrical connection		V/P/Hz	230/1N/50 220-230/1N/60 208/1/60Hz 240/1/60Hz  400V/3N/50Hz 400V/3N/60Hz 400V/3/50Hz 230V/3/50Hz 440V/3/60Hz

### 1.4.1 Overall drawings with measurements

Please, refer to the Installation manual available on the web site <https://www.electroluxprofessional.com> and <https://webgate.electrolux-professional.com>.



## 1.4.2 Main technical data

**Tab.1 – Single Skin Models Main Data (monophase, 50Hz)**

Model		(E-Z-N-V)L1 D-L	(E-Z-N-V) L1G	(E-Z-N)L1P (E-Z-V) L1GMS CL1G ELA3GWP	CL1GU	(E-Z-N-C) LA1G	ELA1.. W, WP <sup>(1)</sup> , P <sup>(1,2)</sup>
Voltage:	V	230/1N	230/1N	230/1N	230/1N	230/1N	230/1N
Frequency	Hz	50	50	50	50	50	50
Standard power input [Max. power input]	kW	3.65 [5.65]	2.85 [4.35]	3.65 [5.65]	2.85 [4.35]	5.35 [7.35]	3.65 [5.65]
Boiler heating power	kW	2.8	1.5	2.8	1.5	4.5	2.8
Tank heating element	kW	2.0	2.0	2.0	2.0	2.0	2.0
Wash Pump	kW	0.8	0.8	0.8	0.8	0.8	0.8
Drain Pump	kW	–	0.25	0.25	0.25	0.25	0.25 <sup>1)</sup>
Supply water pressure	kPa [bar]	180 – 300 [1.8 – 3.0]	180 – 300 [1.8 – 3.0]	180 – 300 [1.8 – 3.0]	180 – 300 [1.8 – 3.0]	180 – 300 [1.8 – 3.0]	180 – 300 [1.8 – 3.0]
Supply water tempera- ture	°C [°F]	50 [122]	50 [122]	50 [122]	50 [122]	50 [122]	50 [122]
Max. Water hardness	°fH[dH]	14[8]	14[8]	14[8]	14[8]	14[8]	14[8]
Concentration of chlorides in water	ppm	<20	<20	<20	<20	<20	<20
Water conductivity	µS/cm	< 400	< 400	< 400	< 400	< 400	< 400
Rinse water consump- tion	L/cycle	3.0	3.0	3.0	3.0	3.0	3.0
Boiler capacity	Lit	12	12	12	12	12	12
Tank capacit	Lit.	33	33	33	33	33	33
Duration of standard cycles with supply wa- ter at 50°C	Sec.	120/180	120/180	120/180	120/180	90/180	120/180 90/120/240 <sup>(2)</sup>
Legal noise level	dB (A)	LpA 67.5dB, KpA 1.5dB (*)					
Protection level		IPX4					
Net weight	kg	47	60	47	60	60	60
Power cable type		H07RN-F – Schuko plug	H07RN-F – Schuko plug	H07RN-F – Schuko plug	H07RN-F – UK plug	H07RN-F – Schuko plug	H07RN-F – Schuko plug

(\*) = The noise emission values have been obtained according to EN ISO 11204.

# SERVICE MANUAL

**Tab.2 – Single Skin Models Main Data (other voltages)**

Model		EL1P6 EL1G6M	ELA1G6	ELA3G6 <sup>(1)</sup> ELA3GTL6 <sup>(2)</sup>	(E-Z-N-V) L3, L3D	(E-Z-N) L3P <sup>(3)</sup> .. (E-Z-N-V) LA3W..P <sup>(3)</sup> ,G	(E-Z-N-V) L3G <sup>(4,5)</sup> VLA3G <sup>(4,6)</sup> ZLA3 <sup>(7)</sup> (E-Z)..LA3G <sup>(4,8)</sup> ELA3GMCD <sup>(4,9)</sup> , ELA3GTL <sup>(4,7)</sup>
Voltage:	V	230/1N	230/1N	230/3	400/3N	400/3N	400/3N
Frequency	Hz	60	60	60	50	50	50
Standard power input [Max. power input]	kW	3.65 [5.65]	5.35 [7.35]	5.35 [7.35]	5.35 [7.35]	5.35 [7.35]	5.35 [7.35]
Boiler heating power	kW	2.8	4.5	4.5	4.5	4.5	4.5
Tank heating element	kW	2.0	2.0	2.0	2.0	2.0	2.0
Wash Pump	kW	0.8	0.8	0.8	0.8	0.8	0.8
Drain Pump	kW	0.25	0.25	0.25	–	0.25 <sup>(3)</sup>	0.25 <sup>(4)</sup>
Supply water pressure	kPa [bar]	180 – 300 [1.8 – 3.0]	180 – 300 [1.8 – 3.0]	180 – 300 [1.8 – 3.0]	180 – 300 [1.8 – 3.0]	180 – 300 [1.8 – 3.0]	180 – 300 [1.8 – 3.0]
Supply water tempera- ture	°C [°F]	50 [122]	50 [122]	50 [122]	50 [122]	50 [122]	50 [122]
Max. Water hardness	°fH[dH]	14[8]	14[8]	14[8]	14[8]	14[8]	14[8]
Concentration of chlorides in water	ppm	<20	<20	<20	<20	<20	<20
Water conductivity	µS/cm	< 400	< 400	< 400	< 400	< 400	< 400
Rinse water consump- tion	L/cycle	3.0	3.0	3.0	3.0	3.0	3.0
Boiler capacity	Lit	12	12	12	12	12	12
Tank capacit	Lit.	33	33	33	33	33	33
Duration of standard cycles with supply wa- ter at 50°C	Sec.	120/180	60/120	75/180/120 <sup>(1)</sup> 90/120/240 <sup>(2)</sup>	120/180	120/180	120/180 <sup>(5)</sup> 90/180 <sup>(6)</sup> 90/120/240 <sup>(7)</sup> 75/180/120 <sup>(8)</sup> 120/180/240 <sup>(9)</sup>
Legal noise level	dB (A)	LpA 67.5dB, KpA 1.5dB (*)					
Protection level		IPX4					
Net weight	kg	60	60	60	47	54	60
Power cable type		H07RN-F – Schuko plug	H07RN-F – No plug	H07RN-F – No plug	H07RN-F – No plug	H07RN-F – No plug	H07RN-F – No plug

(\*) = The noise emission values have been obtained according to EN ISO 11204.

**Tab.3 – Double Skin Models Main Data – 50Hz**

Model		(E-N-C)LA11. ..G ..WG <sup>(1)</sup>	ELAI1GCL	ELI3G5M <sup>(2)</sup> ELI3G35M <sup>(3)</sup>	ELI3,ZLI3 <sup>(4)</sup> (E-Z-N-V <sup>(5)</sup> -X) LA13..P,G, GNR, GTL, W-P/G <sup>(6)</sup>	ELI3CG ELAI3.. ..GWL,PML,G ML,WGML <sup>(6)</sup> ZLI3CD ET5AI..P (E-Z-V <sup>(7)</sup> ).. ..UCA060	ELAI3GCL
Voltage:	V	230/1N	230/1N	400/3 <sup>(2)</sup> 230/3 <sup>(3)</sup>	400/3N	400/3N	400/3N
Frequency	Hz	50	50	50	50	50	50
Standard power input [Max. power input]	kW	5.35 [7.35]	6.85 [8.85]	6.85 [8.85]	5.35 [7.35]	6.85 [8.85]	9.85 [11.85]
Boiler heating power	kW	4,50	6.00	6.00	4.50	6.00	9.00
Tank heating element	kW	2.00	2.00	2.00	2,00	2,00	2,00
Wash Pump	kW	0.80	0.80	0.80	0.80	0.80	0.80
Drain Pump	kW	0,25	0,25	0,25	– <sup>(4)</sup> 0,25	0,25	0,25
Supply water pressure	kPa [bar]	50 – 300 [0.5 – 3.0]	50 – 300 [0.5 – 3.0]	50 – 300 [0.5 – 3.0]	50 – 300 [0.5 – 3.0]	50 – 300 [0.5 – 3.0]	50 – 300 [0.5 – 3.0]
Supply water temperature	°C [°F]	50 [122]	50 [122]	50 [122]	50 [122]	50 [122]	50 [122]
Water hardness	°fH[dH]	14[8] Max.	14[8] Max.	14[8] Max.	14[8] Max.	14[8] Max.	14[8] Max.
Concentration of chlorides in water	ppm	<20	<20	<20	<20	<20	<20
Water conductivity	µS/cm	< 400	< 400	< 400	< 400	< 400	< 400
Rinse water consumption	L/cycle	2.5	2.5	2.5	2.5	2,5	2,5
Boiler capacity	Lit	12	12	12	12	12	12
Tank capacit	Lit.	23	23	23	23	23	23
Duration of standard cycles with supply water at 50°C	Sec.	90/120/240	90/120/240	90/120/240	90/120/240 90/180 <sup>(5)</sup>	90/120/240 90/240 <sup>(7)</sup>	90/120/240
Legal noise level	dB (A)	LpA 61dB, KpA 1.5dB (*)					
Protection level		IPX4					
Net weight	kg	68 71 <sup>(1)</sup>	68	68	68 71 <sup>(6)</sup>	68 71 <sup>(6)</sup>	68
Power cable type		H07RN-F – No plug	H07RN-F – No plug	H07RN-F – No plug	H07RN-F – No plug	H07RN-F – No plug	H07RN-F – No plug

(\*) = The noise emission values have been obtained according to EN ISO 11204.

# SERVICE MANUAL

**Tab.3 – Double Skin Models Main Data – 60Hz**

Model		ELAI1G8 <sup>(1)</sup> VLAI1G8 <sup>(2)</sup>	ELI1G36M	ELAI1G4 <sup>(1)</sup> VLAI1G4 <sup>(2)</sup>	ELAI3P6	ELI3G6M <sup>(4)</sup> ELAI3GUSPH6 <sup>(1)</sup>
Voltage:	V	208/1	230/1	240/1	400/3N	440/3
Frequency	Hz	60	60	60	60	60
Standard power input [Max. power input]	kW	6.85 [8.85]	6.85 [8.85]	6.85 [6.85]	5.35 [7.35]	6.85 [8.85]
Boiler heating power	kW	6.00	6.00	6.00	4.50	6.00
Tank heating element	kW	2.2	2.0	2.2	2,00	2.0
Wash Pump	kW	0.80	0.80	0.80	0.80	0,80
Drain Pump	kW	0,25	0,25	0,25	0,25	0,25
Supply water pressure	kPa [bar]	50 – 300 [0.5 – 3.0]	50 – 300 [0.5 – 3.0]	50 – 300 [0.5 – 3.0]	50 – 300 [0.5 – 3.0]	50 – 300 [0.5 – 3.0]
Supply water temperature	°C [°F]	50 [122]	50 [122]	50 [122]	50 [122]	50 [122]
Water hardness	°fH[dH]	14[8] Max.	14[8] Max.	14[8] Max.	14[8] Max.	14[8] Max.
Concentration of chlorides in water	ppm	<20	<20	<20	<20	<20
Water conductivity	µS/cm	< 400	< 400	< 400	< 400	<400
Rinse water consumption	L/cycle	2.5	2.5	2.5	2.5	2.5
Boiler capacity	Lit	12	12	12	12	12
Tank capacity	Lit.	23	23	23	23	23
Duration of standard cycles with supply water at 50°C	Sec.	120/180/240 <sup>(1)</sup> 120/240 <sup>(2)</sup>	90/120/240	120/180/240 <sup>(1)</sup> 120/240 <sup>(2)</sup>	90/120/240	90/120/240 <sup>(4)</sup> 120/180/240 <sup>(1)</sup>
Legal noise level	dB (A)					
Protection level		IPX4				
Net weight	kg	68	68	68	68	68
Power cable type		H07RN-F – No plug	H07RN-F – No plug	H07RN-F – No plug	H07RN-F – No plug	H07RN-F – No plug

(\*) = The noise emission values have been obtained according to EN ISO 11204.

## 2 INSTALLATION AND COMMISSIONING

---

### 2.1 INSTALLATION

Please, for installation refer to Installation Manual available on website <https://www.electroluxprofessional.com> and <https://webgate.electroluxprofessional.com>

### 2.2 COMMISSIONING

Please, for the commissioning refer to Commissioning Check list available on website <https://www.electroluxprofessional.com> and <https://webgate.electroluxprofessional.com>

To avoid accidents, when debugging the machine please pay special attention to the following:

- The debugging can only be carried out by professional service partner;
- Please check the installation tools and other items are all removed in initial start;
- Check for possible water and chemical leakage;
- Check if the security system and door switch are normal when debugging
- Check that all screws are tightened.

When the installer completes all installation work and all the settings work, the machine can start running.

#### 2.2.1 Function check

A function check must be made when the installation is finished and before the machine can be ready to be used. Whenever a repair has been made, a function check must be performed before the machine can be used again.

##### **Check the interior**

Open the door, make sure that all parts are placed in correct location.

Make sure that there are no irrelevant parts inside the machine (for example: hanging cloth, screws, nuts, tools, packaging materials, etc.).

##### **Water inlet hose**

Please clean the inlet hose before connection. Before initial water feeding, please disconnect all heater and power supply to avoid heating with no feeding water.

##### **Water supply connection and related flow pressure**

Check if the inlet hose is connected firmly, as looseness and leakage may happen in transporting and carrying process. Related non-standard flow pressure can lead to faults of the machine.

##### **Electrical Connection**

Connect the mains plug to the mains socket only at the end of the installation. Make a visual test for all the electrical equipment if they are in good condition, (for example: switches, cables, motor shell, etc.), and test all the functions of power switch.

##### **Check the automatic stop of the machine**

Start the machine and check if the micro switch is working properly: the machine must stop if the door is opened.

##### **Ready to use**

If all tests are OK the machine is now ready to be used. If some of the tests failed, or deficiencies or issues are detected, please contact your local service organization or dealer.

## 2.2.2 Basic operation to test the machine

1. Preliminary checks	1. Water analyses and power supply Spk kit water analyzer :0S0483.	<p>1. Using the special tools indicated in chapter <b>6.1.2 Special tools</b>, perform the following water analyses:</p> <ul style="list-style-type: none"> <li>- Total water hardness;</li> <li>- Temporary water hardness;</li> <li>- Water inlet pressure;</li> <li>- Water inlet temperature;</li> <li>- pH;</li> <li>- Conductivity;</li> <li>- ppm;</li> <li>- Chloride;</li> </ul> <p>In case of water treatment for feeding water (water softener or reverse osmosis) consider to perform the water analyses even upstream the of water treatment. Water quality affects the dosage of detergent and rinse aid. <b>It is strongly recommended Electrolux Professional C11 or C13 Detergent aid.</b> <b>It is strongly recommended Electrolux Professional C12 or C14 Rinse aid.</b></p> <p>2. Check socket power supply is according to value requested by the appliance.</p>
	2. Components fitting check	Make sure the overflow, the tank filter the upper and lower wash arms and the upper and lower rinse arms are correctly fitted.
2. Ensure that the machine water incoming, heating program operates normally.	Open the water supply main tap, connect the plug, close the machine power switch.	<p>1. Observe if the water flows into boiler.</p> <ul style="list-style-type: none"> <li>- if there is sounds of water flow.</li> <li>- check electromagnetic valves for inletting/rinsing is open: (place screwdriver to the coil, if there is magnetic attraction means the valves are connected to power, there is no water passing, or it is broken or the pipe are blocked, the water source are not open).</li> <li>- wait few minutes to see if the water is flowing into tank and spray through the rinse arms-&gt;that means the boiler is full.</li> </ul>
		2. Open and close the door to check if door switch operates correctly stopping the filling valve.
		3. When the water reaches the right level, the pressure switch P1 diverts the contact to power the tank heating element and in the mean time the user interface enables the heaters of the boiler. The temperature probes of the tank NT1 and boiler NT2 provide the information to the UI of the temperatures status and let the UI to command the heaters according to temperature set points. The word "F 1" is shown on the display during the entire filling and heating stage.
		4. Check if the piping system, tank, boilers are leaking.
		5. The warmup has finished when the display shows the tank temperature "55". To display the boiler temperature during heating of the tank, open the door and press the button 7 "Cycle one" on the CONTROL PANEL.
3. Make sure washing rinsing, cold rinsing and draining operate properly.	1. Start a washing cycle when the appliance is ready to be used.	Press start button 7, 8 or 9 on the CONTROL PANEL to enable a washing cycle.
	2. Calibration of the dispensers	<p>The concentration of detergent/rinse aid depends on the type of product used and the hardness of the supply water (check the characteristics on the product label). <b>It is strongly recommended Electrolux Professional C11 or C13 Detergent aid.</b> <b>It is strongly recommended Electrolux Professional C12 or C14 Rinse aid.</b> Set the detergent the dosage according to the chapter 4.6 DETERGENT AND RINSE AID DOSAGE. Enable manually detergent and rinse aid pump to fill all the hoses from the chemical bottles to the tank and to the boiler. Please refer to chapter 4.3 MANUAL ACTIVATION OF DETERGENT AND RINSE AID DISPENSERS.</p>
	3. Start the cleaning cycle	<p>1 Open the door and remove the tank filters and the overflow. 2 Close the door. 3 Select the cleaning and drain cycle by pressing button "3" on the CONTROL PANEL 4 The message "E E" ("CLEAN") will be displayed throughout the drain cycle. 5 After a few minutes, 3 beeps indicate the end of the cleaning cycle and "E n d" blinks on the display.</p>

## 3 USE OF APPLIANCE

### 3.1 OPERATING INSTRUCTIONS

Please refer to the Installation Manual of the appliance available on website <https://www.electroluxprofessional.com> and <https://webgate.electroluxprofessional.com>.

In case of any doubt, refer to your local country Customer Care.

### 3.2 PREVENTIVE ROUTINES/MAINTENANCE FOR THE OPERATOR

Please refer to the Installation Manual of the appliance available on website <https://www.electroluxprofessional.com> and <https://webgate.electroluxprofessional.com>.

In case of any doubt, refer to your local country Customer Care.

### 3.3 PREVENTIVE MAINTENANCE PLAN (FOR SERVICE)

Please, for the Preventive Maintenance Plan refer to the Preventive maintenance checklist available on website: <https://www.electrolux-professional.com> and <https://webgate.electroluxprofessional.com>

In case of any doubt, refer to your local country Customer Care.

Instructions for accessing and replacing components in accordance with Preventive maintenance checklist are given in chapter 6 SERVICING THE APPLIANCE.

#### 3.3.1 Peristaltic tube fitting and replacement instructions

Described below is the procedure for inserting and removing the tubes from the peristaltic pumps, in case of tube replacement.

On the right the exploded view of the components involved in the tube fitting and removal operations.

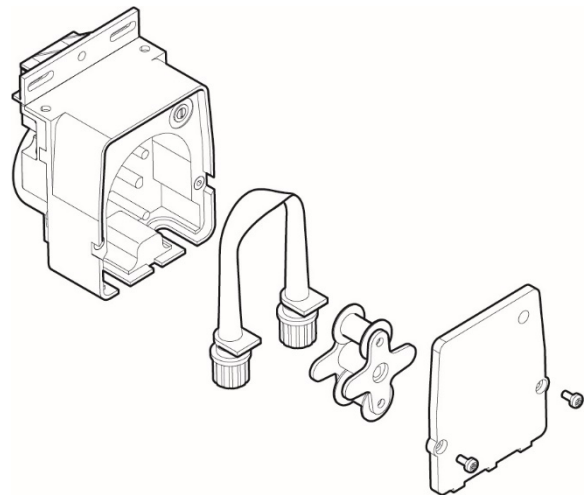

1. Position the roller.
2. Insert the tube of the suction part, turning the roller clockwise.
3. Keep the tube in the seat in the housing and continue turning the roller clockwise, being careful not to damage the tube.
4. Keep the tube in the seat in the housing and continue turning the roller clockwise.
5. Turn the roller completely 360°.
6. Make sure to fit the union in the special seat (delivery).

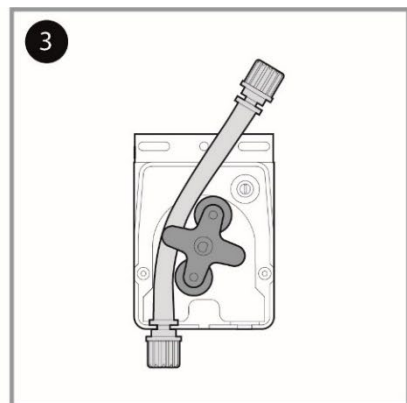
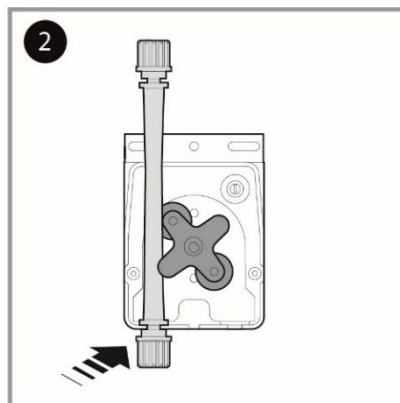
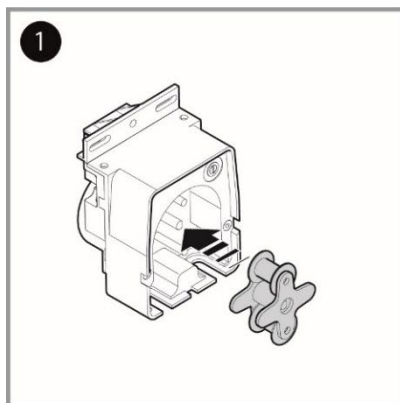

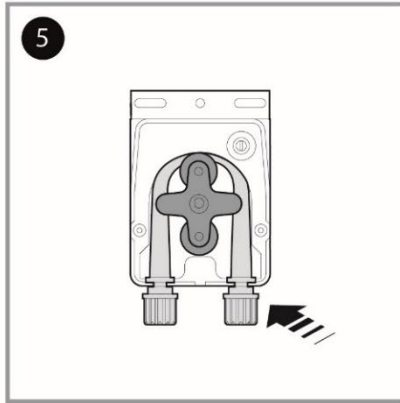
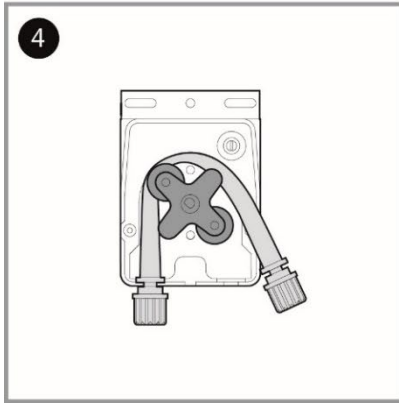

Note: For REMOVAL, proceed as per the figures below:

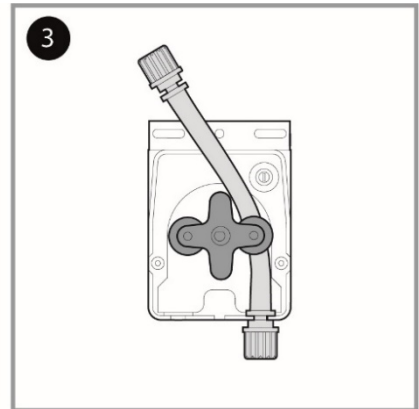
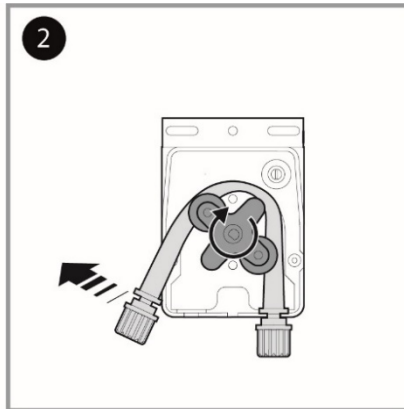
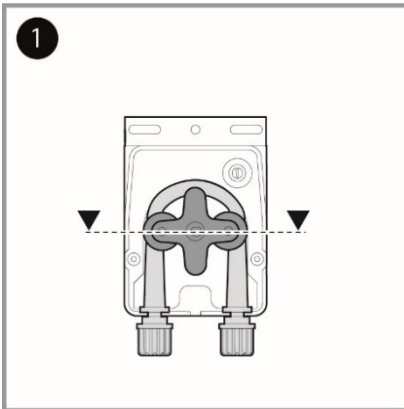



# 4 DETAILED APPLIANCE AND COMPONENTS DESCRIPTION/FUNCTIONING

## 4.1 CONTROL PANEL

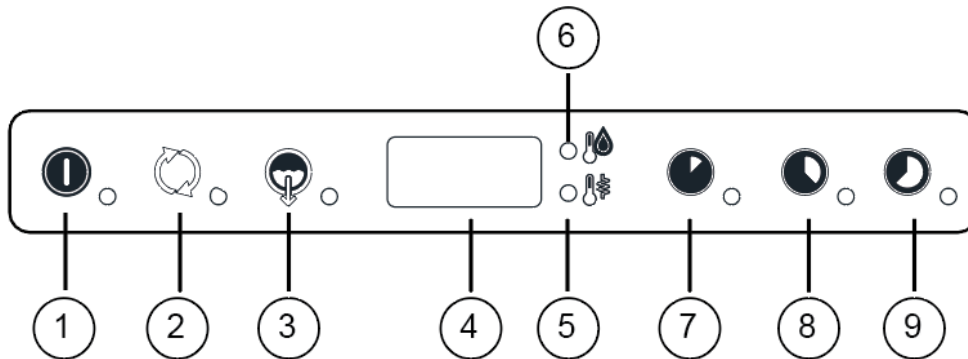

Buton	Descriptions	Buton	Descriptions
1	ON/OFF	5	Boiler temperature
2	Regeneration Cycle	6	Wash tank temperature
3	Drain Cycle	7	Cylce one
4	Display	8	Cycle two
		9	Cycle three

## 4.2 SETTING MODES

To enter into one of the setting mode (Fig.1 or Fig.2) the appliance should be in stand-by: switch ON the appliance, no cycles selected. Is useful keep door open to avoid start cycle in case of not simultaneously pressure of the two keys.

<p>Fig.1</p>	<p>Fig.1 <b>Enter into General Parameters</b> (Hold down buttons for at least five seconds).</p>
<p>Fig.2</p>	<p>Fig.2 <b>Enter into Factory Parameters</b> (Hold down buttons for at least five seconds).</p>
<p>Fig.3</p>	<p>Fig.3 <b>Next Parameter Family/IncreaseParameterValue</b> (in setting mode only)</p>
<p>Fig.4</p>	<p>Fig.4 <b>Decrease Parameter Value</b> (In setting mode only)</p>
<p>Fig.5</p>	<p>Fig.5 <b>Confirm Value and go to next Parameter</b> (in setting mode only)</p>

## 4.3 MANUAL ACTIVATION OF DETERGENT AND RINSE AID DISPENSERS

When replacing detergents may be necessary activate the dispensers to fill hoses.

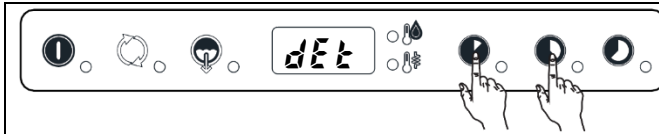

Fig.6  
Detergent dispenser Manual Activation

Fig.6



Fig.7  
Rinse Aid Dispenser Manual Activation

Fig.7

## 4.4 RINSE PUMP MANUAL ACTIVATION

Use this function to empty the boiler (if the dishwasher is not to be used for a long time, for maintenance operation: ex. before replacing main board).

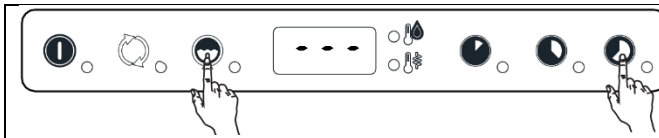

Fig.8  
Rinse Pump Manual Activation  
(used to EMPTY BOILER)

Fig.8

## 4.5 PARAMETERS TREE

### 4.5.1 ON/OFF + Cycle1 keys

GEN	dInz	50
	rInz	10
	dEtz	0
	rAiz	4

Ent	CYC
	cyc
	rSt
	nCY
	drn
	rCY
	nrE
	rES

# SERVICE MANUAL

## 4.5.2 ON/OFF + Cycle 2 keys

<b>FAC</b>	bEt:	80
	bEtH:	2
	bHr:	96
	bLo:	1
	bFL:	5
	bAd:	0
	bP:	1
	bSt:	2
	bEd:	3
	tEt:	63
	tEtH:	5
	tHr:	75
	tLo:	1
	tFL:	20

<b>CY1</b>	Ln1:	1
	Sh1:	10
	PA1:	4
	Pr1:	0
	r1:	16
	cr1:	0
	dr1:	30
	FP1:	0
	tL1:	0
tS1:	59	

<b>CY2</b>	Ln2:	1
	Sh2:	40
	PA2:	4
	Pr2:	0
	r12:	16
	cr2:	0
	dr2:	30
	FP2:	0
	tL2:	1
tS2:	12	

<b>CY3</b>	Ln3:	3
	Sh3:	40
	PA3:	4
	Pr3:	0
	r13:	16
	cr3:	0
	dr3:	30
	FP3:	0
	tL3:	2
	tS3:	12
bt3:	0	

<b>drn</b>	ldr:	30
	Fdr:	80
	drk:	0
	Lbd:	0
	dko:	18

<b>dPA</b>	lPA:	0
	dLY:	3
	Pdr:	0
	rPA:	0
	L F:	0
	r1k:	0
	PPL:	0
	LdE:	5
	tLE:	0
	btL:	86
	tL:	75
	tHk:	2
	LrE:	0
	DFt:	60
FUL:	9	

<b>ron</b>	rEL
	rLS
	REC
	CA1
	L B
	F21

<b>HCP</b>	SEr:	1
	Adr:	1
	Prn:	1
	bt:	90
	bH:	10
	tH:	10

<b>CFU</b>	tYP:	0
	boi:	0
	dao:	2
	dFL:	-
	trc:	1
	b.t:	1
	btF:	75
	LES:	0
	U1:	9
	rE:	0
	ALr:	1
	ARG:	0
	FrU:	0
SrU:	10	
bPo:	50	

<b>dbU</b>	t 1:	15
	t 2:	200
	t 3:	15
	t 4:	10
	t 5:	20
	t 6:	20
	AL:	0
	tkh:	100

## 4.6 DETERGENT AND RINSE AID DOSAGE

In this paragraph is explained how to set the working time for the detergent and rinse aid dispensers. For each dispenser there are two parameters: the initial time and the time during cycle execution.

### GEN General Parameters

Sym	Parameter Description	Unit	Min	Max	Factory Default
<i>d in</i>	Initial Detergent Dosage (during filling tank)	[s]	0	240	50
<i>r in</i>	Initial Rinse Aid Dosage (starts when tank filled)	[s]	0	180	10
<i>dEt</i>	Detergent Dosage During Cycle Execution (during wash phase)	[s]	0	182(*)	8
<i>rA.</i>	Rinse Aid Dosage During Cycle Execution (when refill- ing boiler)	[s]	0	62(*)	4

How change the duration:

- Turn the dishwasher off and then on again;

Enter the "General Parameters" edit mode by pressing and holding down the ON/OFF and CYCLE\_1 buttons for **approx. 5 sec.** The display shows **GEN** (Fig.1

- ;
- Press CYCLE\_3. The display shows alternatively the symbol *d in* (Initial detergent) and the duration in seconds



Initial detergent

- Use the CYCLE\_1 button to decrease the value and CYCLE\_2 to increase it:



Decrease duration



Increase duration

- After choosing the value, press CYCLE\_3 to confirm the selection and go to the next parameter. The display shows the *r in* parameter and the corresponding value:



Initial rinse aid.

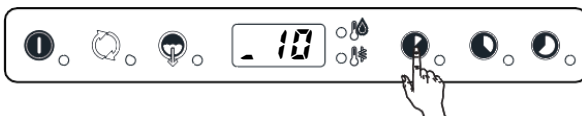

Decrease duration

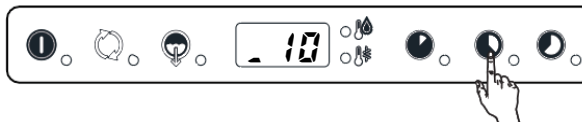

Increase duration

- Similarly it is possible to change the other values:



Detergent for cycle.

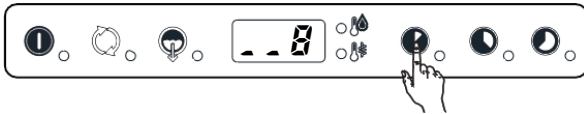

Decrease duration



Increase duration



Rinse aid for cycle.

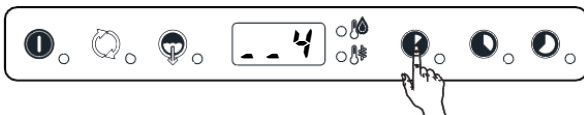

Decrease duration



Increase duration

Afterwards turn the machine off and then on again.

## 4.7 (\*)NOTE FOR EXTERNAL DISPENSER

- If  $dEt = 181$  the **detergent dispenser** works when **WASHING PUMP** is being activated; at the same time voltage is supplied between connectors **L17-L19** (main terminal box);
- If  $dEt = 182$  the **detergent dispenser** works when **LOADING EV** is being activated to re-fill boiler level; at the same time voltage is supplied between connectors **L17-L19** (main terminal box);
- If  $rA = 61$  the **rinse aid dispenser** works when **LOADING EV** is being activated to re-fill boiler level; at the same time voltage is supplied between connectors **L18-L19** (main terminal box);
- If  $rA = 62$  the **rinse aid dispenser** works when **WASHING PUMP** is being activated; at the same time voltage is supplied between connectors **L18-L19** (main terminal box);

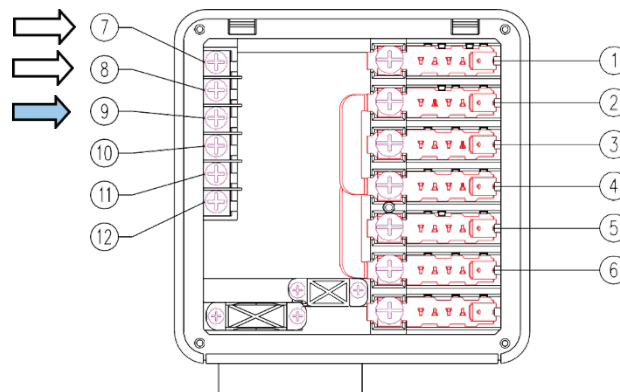

For electrical connections refer to electric diagram.

### Example

Suppose there is connected an **external detergent dispenser** with a probe into the tank. A typical setting could be

$dIn = 0$  the dispenser is not activated during filling tank;

$dEt = 181$  the dispenser is supplied during washing phase and the probe automatically dose the right detergent amount.

## 4.8 COUNTERS

This Parameter Family collects cycle counters and water consumption counters.

For water consumption counters a flow meter must be installed. See *PP1* (calibration parameter) into *dPA* section (4.17 **dPA- DISH-WASHING PARAMETERS**).

## 4.9 CNT COUNTERS

Sym	Parameter Description	Unit	Min	Max	Factory Default
<i>LYL</i>	Cycles performed counter. <i>LYL</i> symbol and two numbers blink consecutively. The cycle number is obtained by joining the two numbers. Ex. <i>LYL</i> → 10 → 042 means 10042 cycles executed.				
<i>cyc</i>	Cycle counter (resettable). This counter is similar to <i>LYL</i> but is resettable by user (see <i>rSt</i> parameter below).				
<i>mmc</i>	Water Consumption (only for dishwashers with incorporated continuous water softener). Counts m <sup>3</sup> of water consumption.	m <sup>3</sup>			
<i>L</i>	Water Consumption (only for dishwashers with incorporated continuous water softener). Counts litres of water consumption. The total consumption is given by adding <i>mmc</i> [m <sup>3</sup> ] and <i>L</i> [l] values	l			
<i>L l</i>	Water Consumption: resettable counter. Counts the litres of water and is resettable by user (see <i>rSt</i> parameter below).	l			
<i>rSt</i>	Reset resettable counters: <i>cyc</i> and <i>L l</i> . To reset put 1 this parameter, switch off and then on again: <i>cyc</i> and <i>L l</i> will show zero. Note that <i>cyc</i> is used to count cycles for <i>ERR</i> message (see next parameter, <i>nCY</i> ).				
<i>nCY</i>	Store thousand of cycles after that <i>ERR</i> message appears on display. Ex. If this parameter is settled to 20, <i>ERR</i> message appears when <i>cyc</i> reach 20.000 cycles.				
<i>drc</i>	Drain/Cleaning cycles performed. Similar to <i>LYL</i> but counts Cleaning Cycles.				
<i>rCY</i>	Number of cycles that can be made after a regeneration cycle (only for dishwashers with non-continuous water softener) [See chapter 4.21 RESIN REGENERATION CYCLE].				20
<i>nrE</i>	Regeneration cycle counter (only for water softener dishwasher) [See chapter 4.24 DISHWASHER WITH INCORPORATED CONTINUOUS WATER SOFTENER]. <i>nrE</i> only counts efficient regeneration cycles, i.e. those carried out with salt in the special container (only for dishwashers with incorporated continuous water softener)				
<i>rES</i>	Counter of regeneration cycles done without salt in the special container. (only for dishwashers with incorporated continuous water softener). [See chapter 4.24 DISHWASHER WITH INCORPORATED CONTINUOUS WATER SOFTENER].				

## 4.10 TEMPERATURE SETTING

In this paragraph is explained how to change temperature thresholds and all parameters related to boiler and tank.

### FAC Factory Parameters

Sym	Parameter Description	Unit	Min	Max	Factory Default
<i>b t t</i>	Boiler Temperature: THRESHOLD. When the boiler temperature reaches this value, heaters switch off	°C	45	95	<b>80</b>
<i>b t H</i>	Boiler Temperature HISTERESIS, (represent dead band). Heater switch on if boiler temperature is below: <i>b t t</i> - <i>b t H</i>	°C	2	10	<b>2</b>
<i>b H i</i>	Boiler Temperature: HIGH LIMIT. When boiler temperature reaches this value <i>t - 2</i> alarm appears. Put 0 to disable <i>t - 2</i> alarm	°C	0	98	<b>96</b>
<i>b l o</i>	Boiler Temperature: LOW LIMIT. During boiler warm-up, temperature must increase at least <i>b l o</i> °C otherwise <i>E - 3</i> warning appears. Put 0 to disable <i>E - 3</i> warning	°C	0	10	<b>1</b>
<i>b F L</i>	Boiler Filling Timeout. If filling time is longer than <i>b F L</i> , <i>A - 1</i> alarm appears. Put 0 to disable <i>A - 1</i> alarm.	[min]	0	42	<b>5</b>
<i>b A U</i>	Boiler Temperature Adjust.	°C	0	7	<b>0</b>
<i>b P</i>	Boiler Priority (enable boiler wait function 0=disabled -1=enabled	-	0	1	<b>1</b>
<i>b S t</i>	Booster Function. Overheat gap over Boiler Temperature Threshold	°C	0	15	<b>2</b>
<i>b t d</i>	Boiler temperature negative differential: when the dishwasher is in standby, boiler threshold becomes: <i>b t t</i> - <i>b t d</i> (Used to save energy during machine inactivity by keeping boiler water at a lower temperature).	°C	0	20	<b>3</b>
<i>t t t</i>	Tank Temperature: THRESHOLD When tank temperature reaches this value, heater switch off.	°C	40	85	<b>63</b>
<i>t t H</i>	Tub Temperature: HISTERESIS, (represent dead band). Heater switch on if tank temperature is below: <i>t t t</i> - <i>t t H</i>	°C	2	30	<b>5</b>
<i>t H i</i>	Tank Temperature: HIGH LIMIT. When tank temperature reaches this value <i>t 3</i> alarm appears Put 0 to disable <i>t 3</i> alarm.	°C	0	95	<b>75</b>
<i>t l o</i>	Tank Temperature: LOW LIMIT During tank warm-up, temperature must increase at least <i>t l o</i> °C otherwise <i>E 2</i> warning appears. Put 0 to disable <i>E 2</i> warning.	°C	0	10	<b>1</b>
<i>t F L</i>	Tank Filling Timeout. If filling time is longer than <i>t F L</i> , <i>A 1</i> alarm appears. Put 0 to disable <i>A 1</i> alarm.	[min]	0	42	<b>20</b>

To modify thresholds do the following:

- Switch OFF and switch ON the dishwasher;

Enter into the FACTORY SETTING mode by pressing and hold down ON/OFF and CYCLE\_2 keys for at least five seconds (Fig.2);

- Press CYCLE\_3. The display shows alternatively the symbol *b t t* and the corresponding value **75**;
- Use CYCLE\_1 key to decrease the value (Fig.4) and CYCLE\_2 key to increase (Fig.3);
- Press CYCLE\_3 key to confirm (Fig.5).
- The display shows the next parameter and the corresponding value;
- In the same way is possible to change the other parameters; when finished switch OFF and switch ON.

## 4.11 CYCLES SETTING

In this paragraph is explained how to change cycle phases duration (see next paragraph):

- Enter into the FACTORY SETTING mode: press and hold down ON/OFF and CYCLE\_2 keys for at least **5 seconds** (Fig.2).
- Press CYCLE\_2 (Fig.3) key to find CYCLE\_1 parameters, and enter in the sub parameters family pressing find CYCLE\_3 button (Fig.5).
- Press CYCLE\_3 button (Fig.5): the display shows alternatively the symbol *Ln* and the corresponding value *5*. Use CYCLE\_1 key to decrease the value (Fig.4) and CYCLE\_2 key to increase (Fig.3).
- Press CYCLE\_3 key to confirm (Fig.5).
- The display shows the next parameter and the corresponding value; in the same way is possible to change the other parameters. After having set all parameters referring to Cycle 1, by pressing CYCLE\_2 key is possible to change the Cycle 2 parameters and so on.

## 4.12 CYCLE DIAGRAM

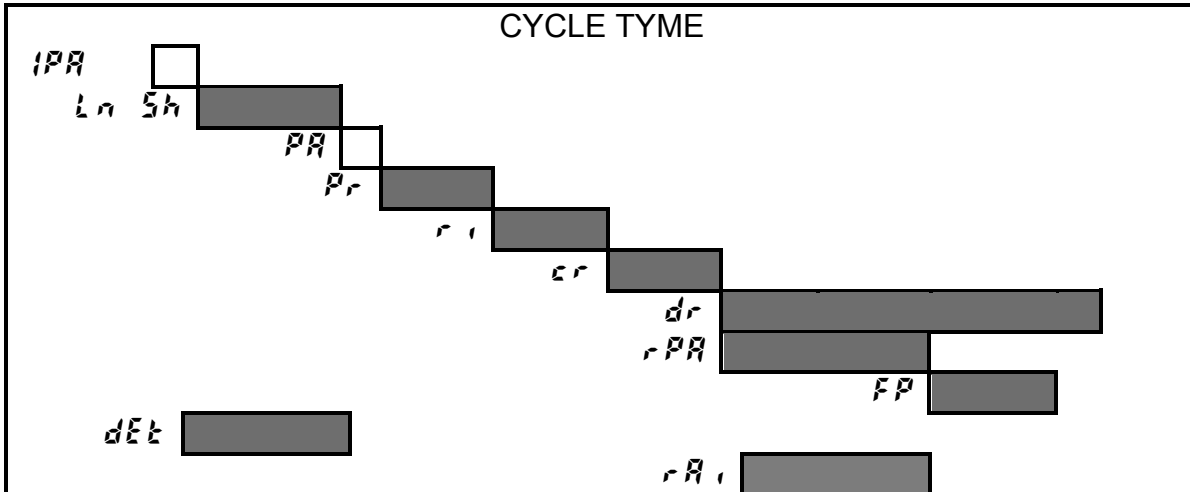

LEGENDA					
<i>Ln Sh</i>	=	Wash	<i>dr</i>	=	Drain
<i>Pr</i>	=	Pre rinse	<i>r-PA</i>	=	Rinse pause
<i>r i</i>	=	Rinse	<i>FP</i>	=	Final pause
<i>cr</i>	=	Cold rinse	<i>dEt</i>	=	Detergent
			<i>rA i</i>	=	Rinse aid



### 4.13 Cy1 – CYCLE 1 PARAMETERS

Sym	Parameter Description	Unit	Min	Max	Factory Default
<i>Ln1</i>	Wash Phase Long	[min]	0	20	1
<i>Sh1</i>	Wash Phase Short	[s]	1	60	10
<i>PA1</i>	Pause	[s]	0	20	4
<i>Pr1</i>	Pre-rinse Duration	[s]	0	30	0
<i>r11</i>	Rinse Phase Duration	[s]	10	45	16
<i>cr1</i>	Cold Rinse Phase Duration	[s]	0	50	0
<i>dr1</i>	Drain	[s]	0	40	30
<i>FP1</i>	Final Pause at End of Cycle	[s]	0	60	0
<i>tL1</i>	Long wash time in mode Thermal Label	[min]	0	60	0
<i>tS1</i>	Short wash time in mode Thermal Label	[s]	0	60	59

### 4.14 Cy2 – CYCLE 2 PARAMETERS

Sym	Parameter Description	Unit	Min	Max	Factory Default
<i>Ln2</i>	Wash Phase Long	[min]	0	20	1
<i>Sh2</i>	Wash Phase Short	[s]	1	60	10
<i>PA2</i>	Pause	[s]	0	20	4
<i>Pr2</i>	Pre-rinse Duration	[s]	0	30	0
<i>r12</i>	Rinse Phase Duration	[s]	10	45	16
<i>cr2</i>	Cold Rinse Phase Duration	[s]	0	50	0
<i>dr2</i>	Drain	[s]	0	40	30
<i>FP2</i>	Final Pause at End of Cycle	[s]	0	60	0
<i>tL2</i>	Long wash time in mode Thermal Label	[min]	0	60	1
<i>tS2</i>	Short wash time in mode Thermal Label	[s]	0	60	12

### 4.15 Cy3 – CYCLE 3 PARAMETERS

Sym	Parameter Description	Unit	Min	Max	Factory Default
<i>Ln3</i>	Wash Phase Long	[min]	0	20	3
<i>Sh3</i>	Wash Phase Short	[s]	1	60	40
<i>PA3</i>	Pause	[s]	0	20	4
<i>Pr3</i>	Pre-rinse Duration	[s]	0	30	0
<i>r13</i>	Rinse Phase Duration	[s]	10	45	16
<i>cr3</i>	Cold Rinse Phase Duration	[s]	0	50	0
<i>dr3</i>	Drain	[s]	0	40	30
<i>FP3</i>	Final Pause at End of Cycle	[s]	0	60	0
<i>tL3</i>	Long wash time in mode Thermal Label	[min]	0	60	2
<i>tS3</i>	Short wash time in mode Thermal Label	[s]	0	60	12
<i>bt3</i>	Boiler Temperature Threshold: only for Cycle 3. This parameter allows having a different rinsing temperature for the third cycle. Only values above 45°C are allowed.	[°C]	0	95	0

## 4.16 DRN – DRAIN/CLEANING CYCLE PARAMETERS

Sym	Parameter Description	Unit	Min	Max	Factory Default
<i>ldr</i>	Initial Drain Phase Duration	[s]	0	240	<b>30</b>
<i>fdr</i>	Final Drain Phase Duration	[s]	0	240	<b>80</b>
<i>drt</i>	Drain without cleaning cycle	-	0	1	<b>0</b>
<i>cbd</i>	Number of wash cycles possible between one drain cycle and the next	[wash cycles]	0	200	<b>0</b>
<i>dto</i>	Indicates the maximum permissible delay between drain cycle start and the reaching of a tank level below the work level. If the set delay is exceeded, alarm B1 occurs.	[s] x 10	0	100	<b>18</b>

## 4.17 dPA– DISHWASHING PARAMETERS

Sym	Parameter Description	Unit	Min	Max	Factory Default
<i>ipa</i>	Initial Pause before start washing (for ALL cycles)	[s]	0	10	<b>0</b>
<i>dly</i>	Delay for the 2 <sup>nd</sup> wash pump (Not available for undercounter dishwasher)	[s]	0	10	<b>3</b>
<i>pdr</i>	Active a drain phase at the end of washing phase.	[s]	0	40	<b>0</b>
<i>rpa</i>	Duration of pause after rinse cycle (valid for dishwashers with door lock device) [See paragraph 4.22 MEDICAL LINE DISHWASHER WITH DOOR LOCK DEVICE]	[s]	0	60	<b>0</b>
<i>cf</i>	Celsius/Fahrenheit selection 0 = Celsius 1 = Fahrenheit	-	0	1	<b>0</b>
<i>rit</i>	Enable rinse temperature probe (if installed). 0 = during rinse phase the display shows boiler temperature 1 = during rinse phase the display shows rinse temperature	-	0	1	<b>0</b>
<i>ppl</i>	Pulse Per Litre. This parameter must be settled in according to flow meter installed.	[p/l]	0	255	<b>0</b>
<i>cde</i>	Number of wash cycles performable without detergent (only dishwasher with external detergent level sensor-paragraph 4.23 DETERGENT AND RINSE AID LEVEL SENSORS ACTIVATION).	-	0	5	<b>5</b>
<i>tle</i>	Enable Thermal Label mode: 0 = disabled 1 = enabled	-	0	1	<b>0</b>
<i>btl</i>	Boiler temperature in mode Thermal Label.	[°C]	45	97	<b>86</b>
<i>ttl</i>	Tank temperature in mode Thermal Label.	[°C]	40	90	<b>75</b>
<i>tht</i>	Tank temperature hysteresis in mode Thermal Label.	[°C]	0	30	<b>2</b>
<i>cre</i>	Cold rinse mode: 0 = disabled 1 = enabled	-	0	1	<b>0</b>
<i>oft</i>	Overflow time: the time from when the overflow pressure switch opens to when the drain pump stops.	[s]	0	100	<b>60</b>
<i>ful</i>	Additional loading time: the time from when the tank level pressure switch opens to when the loading valve stops.	[s]	0	25	<b>9</b>

### 4.18 r on– READ ONLY PARAMETERS

Sym	Parameter Description	Unit	Min	Max	Factory Default
rEL	Main Board Firmware Release	-	-	-	-
rLS	Water softener card software version (only for dishwashers with incorporated continuous water softener).	-	-	-	-
ACC	Active column: indicates through which of the two continuous water softener columns boiler filling is being carried out: 0 = Column A 1 = Column B (only for dishwashers with incorporated continuous water softener).	-	-	-	-
CAI	When CAI message appears, the parameter value becomes 3. After maintenance, to clear CAI message, insert 0.	-	-	-	-
CB	When CB alarm appears, the machine is frozen and this parameter is 3. After maintenance (see alarm codes document), insert 0 to enable the machine.	-	-	-	-
F21	This alarm appears in case of malfunctioning in the continuous water softener. To facilitate fault-finding, see paragraph 5 TROUBLESHOOTING.	-	-	-	-

### 4.19 HCP– COMMUNICATION AND HACCP PARAMETERS

Sym	Parameter Description	Unit	Min	Max	Factory Default
SEr	Serial Device 0 = 8N1 1 = PC connection (DAAS 8E1) 7 = HACCP network (ECAP 8E1+LK485) (LK485 board is necessary) 9 = Dishwashers with incorporated continuous water softener 16 = HACCP printer (8N1) 32 = MODEM GSM (DAAS 8N1) 33 = MODEM GSM (DAAS 8E1) 48 = Hyper Terminal (8N1)	-	0	63	1
Adr	Address. This parameter specifies the address of the appliance into the HACCP_network' Works only if 'HACCP network' is selected (see above parameter).	-	0	255	1
Prn	Print parameter table	-	0	1	1
bH	HACCP 'Basic' (printer) Boiler temperature: high limit	[°C]	45	95	90
bH	HACCP 'Basic' (printer) Boiler temperature: gap below high limit	[°C]	0	20	10
tH	HACCP 'Basic' (printer) Tank temperature: high limit	[°C]	35	75	68
tH	HACCP 'Basic' (printer) Tank temperature: gap below high limit.	[°C]	0	20	10

### 4.20 CFG– CONFIGURATION PARAMETERS

Sym	Parameter Description	Unit	Min	Max	Factory Default
tYP	Dishwasher Model 0 = UNDERCOUNTER & GLASSWASHER 1 = POT WASHER 2 = AUTOMATIC POT WASHER 3 = MEDICAL LINE DISHWASHER WITH LOCK DOOR DEVICE	-	0	3	0
boi	Boiler type: 0 = ATMOSPHERIC BOILER 1 = PRESSURE BOILER 2 = EXTERNAL BOILER	-	0	2	0

# SERVICE MANUAL

Sym	Parameter Description	Unit	Min	Max	Factory Default
<i>doo</i>	Door type: 0 = AUTOMATIC HOOD 1 = MANUAL HOOD 2 = FRONT LOADING 3 = AUTOMATIC POT WASHER	-	0	3	2
<i>dfl</i>	Factory Values: 3 = Automatic default configuration for Glasswashr/Undercounter dishwasher. Set this parameter only after the user interface replacement	-	0	3	-
<i>trc</i>	Solid State Relay (TRIAC). 0 = not enabled; 1 = <b>SOFT START</b> enabled 3 = <b>SLOW SOFT START</b> enabled (works only on boards with Solid State Relay).	-	0	3	1
<i>b-t</i>	Boiler/Tank heating swap: 0 = boiler heaters and tank heater can work simultaneously; 1 = swap enabled: tank heating starts only boiler temperature is reached; 2 = The booster heating elements and the wash pump have priority. The tank heating element is activated only when the booster has reached the set temperature and the wash pump is not working. (Note: disabling this function changes the global electrical power of appliance; before enabling this function check available power, supply cable section, fuses in according to User Manual).	-	0	2	1
<i>btf</i>	Tank Filling Mode Enable filling tank by means of rinsing cycles. Ex: <i>btf</i> = 75 means that boiler water is heated at 75°C, then follows a rinse phase and so on until tank is full. If <i>btf</i> = 0 the tank is filled by solenoid valve in the traditional way (On machines with incorporated continuous water softener, even if <i>btf</i> is set to 0, filling occurs through subsequent rinses)	[°C]	0	85	75
<i>LES</i>	Detergent Level Switches 0 = level switches not enabled; 1 = enable detergent level switches.	-	0	1	0
<i>ui</i>	USER INTERFACE 8 = WASH SAFE/ACTIVE function disabled and Cycle 3 available 9 = WASH SAFE/ACTIVE function enabled and Cycle 3 available 24 = WASH SAFE/ACTIVE function disabled and Cycle 3 not available 25 = WASH SAFE/ACTIVE function enabled and Cycle 3 not available	-	0	27	9
<i>re</i>	Enable "regeneration cycle" key (only for dishwashers with not continuous water softener) [See paragraph 4.21 RESIN REGENERATION CYCLE]. 0 = disabled 1 = enabled	-	0	1	0
<i>ALr</i>	ALARMS ENABLE 0 = alarms disabled (to disable also warnings see <i>bl a</i> and <i>tl a</i> ); 1 = alarms enabled; If this function is disabled, faults can be detected so display do not shows any alarm code.	-	0	1	1
<i>ARG</i>	Air gap with float level sensor normally closed (the level sensor is closed when the boiler is empty). E.g. the boiler level sensor for machines with incorporated continuous water softener.	-	0	1	0
<i>FRG</i>	Forced start of a resin regeneration cycle (only for dishwashers with incorporated continuous water softener). [See chapter 4.24 DISHWASHER WITH INCORPORATED CONTINUOUS WATER SOFTENER].	-	0	2	0
<i>Sru</i>	Max. rinse water hardness (only for dishwashers with incorporated continuous water softener). After modifying, disconnect and reconnect the machine's main power supply by means of the main switch [See chapter 4.24 DISHWASHER WITH INCORPORATED CONTINUOUS WATER SOFTENER].	°fH	4	14	10
<i>bPa</i>	Boiler heating control. Defines the max. permissible temperature difference during boiler heating in a time interval of 2 minutes and 30 seconds.	°C	25	80	50

## 4.21 RESIN REGENERATION CYCLE

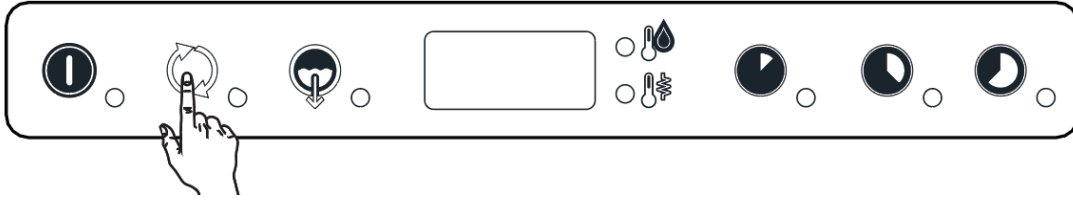

The regeneration cycle is activated by pressing the button shown in the figure, for at least 5 seconds. For this key to be enabled parameter *rE* (in family *CFU*) must be set to 1.

At this point you can enter the number of wash cycles that can be performed after each regeneration: parameter *rCY* in the counters family *Cnt*. If *rCY* is set to zero the counter is disabled, otherwise after the pre-set number of cycles the message *rEE* is displayed to confirm that regeneration is possible (this is an information-only message with no effect on operation of the appliance, so you can continue to use the dishwasher). The message is cleared when the regeneration cycle is terminated.

The number of regeneration cycles performed can be checked by consulting the parameter *nrE* in the *Cnt* family of counters.

When there are just 15 cycles remaining before the next regeneration cycle, at the end of the wash cycle the display shows the message *End* followed by *15*, at the end of the next wash cycle the display shows *End* and *14*, and so forth, i.e. the display informs the user of the number of wash cycles still available before resin regeneration is required.

Before starting the regeneration cycle remove the siphon spillway.

### WARNING:

**If the regeneration cycle is accidentally started, it can be switched off by pressing the button shown in the figure, for at least 5 seconds**

The hardness of the water exiting the softener can vary between 3°f - 10 °f / 1.7 °d - 5.6 °d / 2.1 °e - 7 °e.

## 4.22 MEDICAL LINE DISHWASHER WITH DOOR LOCK DEVICE

The medical line dishwasher with door/hood lock device has a device that prevents door/hood opening for the entire duration of the work cycle. For the door/hood lock to be active, the parameter *LYP* (in the *CFU* family) must be set to *3*. The dishwasher door/hood is locked at the start of a wash cycle and is released at the end of the final pause after rinse. The wash compartment can be accessed by stopping the work cycle in progress, as the locking device is thus disabled. A pause at the end of rinse can be set by means of the parameter *rPA* (in the *dPA* family). This parameter is common to all 3 wash cycles. The rinse water temperature is displayed during this pause. Another final pause in the cycle can be set by setting the parameters *FP1, FP2, FP3*. During the final pause the display shows the time remaining for completion of the cycle. The door/hood lock device will be deactivated at the end of the final pause (*FP1, FP2, FP3*). For correct performance of the wash cycle the pause at the end of rinse and the final pause must assume the default values. Please refer to the Programming parameter list.

## 4.23 DETERGENT AND RINSE AID LEVEL SENSORS ACTIVATION

By setting the parameter *LES* (in the *CFU* family) to 1, management of the level sensors located inside the external detergent and rinse aid tanks is enabled. During the rinse phase, when the rinse aid inside the tank has finished, the message *rA 0* appears on the display. When the detergent inside the tank is finished, the message *det 0* is displayed and after a number of wash cycles equal to *LE* (in the *dPA* family) the dishwasher inhibits the activation of other wash cycles. Therefore the detergent level in the tank must be restored.

## 4.24 DISHWASHER WITH INCORPORATED CONTINUOUS WATER SOFTENER

Dishwashers with incorporated continuous water softener have a continuous softener in the water circuit. By means of special resins, this device removes the calcareous substances from the feed water, supplying decalcified water for washing.

To activate the continuous water softener, set the parameter *SEr* (in the *HCP* family) to the value *9*.

For the continuous softener to work properly the resins must be regenerated periodically with a frequency depending on the hardness of the inlet water, the number of wash cycles carried out and the max. hardness set with the parameter *SrU* (in the *CFU* family).

Unlike conventional water softeners, this continuous softener does not require machine stops for regenerating the resins.

To regenerate the resins it is necessary to put coarse salt in the special container located in the dishwasher.

# SERVICE MANUAL

In particular, the salt container must be filled when the dishwasher is started the first time and whenever the message **SAL End** appears on the display and an audible alarm sounds. The salt container holds up to 1.5 kg of salt

**WARNING:**

**Use only coarse salt with a NaCl purity grade of 99.8 %. The use of salt with a lower purity grade may cause the salt container filter to clog and the water softener to malfunction.**

**WARNING:**

**The message SAL END may appear, for several rinse, tank filling or wash cycles, even after replenishing the salt, as the salt must circulate in the entire system. This, however, does not affect correct dishwasher operation.**

The number of regeneration cycles performed can be checked by consulting the parameter **nrE** in the **Ent** family of counters. **nrE** only counts regeneration cycles carried out with the salt container adequately filled; there is another counter, **rES** (in the **Ent** family) that indicates the number of regeneration cycles done without salt.

If the parameter **SrU** is set to the value 10, according to the factory setting, the water softener outlet water hardness can vary between 3°f-10°f/1.7 °d-5.6 °d / 2.1 °e - 7 °e.

**AUTONOMY OF THE FULL SALT CONTAINER ACCORDING TO THE CHANGE IN INLET WATER HARNESS**

Water hardness			(Column A)	(Column B)
			The salt container must be filled approximately every (*):	Using cycle 2 for 30 cycles/day, the salt container must be filled approximately every (*):
°f	°d	°e	Cycles	Days
15	8,4	10,5	1168	39
20	11,2	14	837	28
25	14	17,5	589	19
30	16,8	21,1	506	17
35	19,6	24,6	423	14
40	22,4	28,1	341	11

(\*). Considering a rinse time according to the factory settings.

Maximum outlet water hardness can be modified by setting the **SrU** value. The outlet water hardness can be modified from the value of 4° f to 14° f.

**NB:** To save the new water hardness value, in addition to the normal parameter modification and saving operations it is necessary to disconnect and reconnect the machine's main power supply by means of the main switch on the external board.

Water softener operation can be checked by forcing the regeneration of resins, without waiting for the outlet water hardness to reach the set max. value (**SrU**).

To do this, wait for the water softener to finish previous resin washing or regeneration operations and set the parameter **FrG** (**LFU** family) to **1** for regenerating column A or to **2** for regenerating column B.

Switch the machine off and on again so that it carries out complete regeneration of the set column. If previous resin washing or regeneration operations were not completed, the manual request for regeneration is not carried out.

It is possible to check which column is being used for boiler filling by querying the parameter **RAE** (**rOn** family): if **RAE** = 0 column "A" is used, if **RAE** = 1 column "B" is used.

The number of litres used by the machine can be checked by querying the parameters **nnC** (m3) and **L** (litres). To calculate the total number of litres used by the machine, add the **nnC** and **L** values.

**NB:** In machines with incorporated continuous water softener, tank filling must be done through subsequent rinses from the boiler and cannot occur by overflow since the filling system does not allow overflow in the tank. Therefore, even if the parameter **bLF** is set to **0**, filling is done by subsequent rinses..

# 5 TROUBLESHOOTING

## 5.1 GENERAL TROUBLESHOOTING

Event number	Anomaly	Type of Anomaly	General description	Possible cause	Instruction to User	Service Action
1	Glasswasher does not switch on	Machine blocked	ON/OFF Button is not lit up. The dishwasher does not start to fill water.	<ol style="list-style-type: none"> <li>1) Tripped circuit breaker of power supply.</li> <li>2) Appliance not properly supplied.</li> <li>3) Electric filter K2 faulty.</li> <li>4) User interface A2 faulty.</li> <li>5) Main board A1 faulty.</li> </ol>	<ol style="list-style-type: none"> <li>1) Switch on the circuit breaker in the main electrical table.</li> <li>2) Please call Service Center</li> <li>3) Please call Service Center</li> <li>4) Please call Service Center</li> <li>5) Please call Service Center</li> </ol>	<ol style="list-style-type: none"> <li>2) Check supply voltage on the main terminal: if it wrong, alert the customer it could be a failure of its electrical network breakdown.</li> <li>3) Replace Electric filter K2.</li> <li>4) Replace User interface A2.</li> <li>5) Replace Main board A1.</li> </ol>
2	Glasswasher detects door open when the door is closed	Machine blocked	User interface show "CLOSE" when the door is close	<ol style="list-style-type: none"> <li>1) Door switch faulty</li> <li>2) User interface A2 faulty.</li> </ol>	Please call Service Center	<ol style="list-style-type: none"> <li>1) Replace the door switch.</li> <li>2) Replace User interface A2.</li> </ol>
3	Glasswasher does not start the washing cycle after press start button	Machine blocked	Machine is ready but not start after pressing start button	<ol style="list-style-type: none"> <li>1) User interface A2 faulty.</li> <li>2) Main board A1 faulty.</li> </ol>	Please call Service Center	<ol style="list-style-type: none"> <li>1) Replace User interface A2.</li> <li>2) Replace Main board A1.</li> </ol>
4	Dishes/Glasses not cleaned	Loss of performance	Dirt and food residues on the surface of dishes/glasses.	<ol style="list-style-type: none"> <li>1) No scrape action before putting the rack in the glasswasher</li> <li>2) Dishwasher is running with-out detergent-aid.</li> <li>3) Tank filter of machine is not correctly fitted or missing</li> <li>4) Wash/rinse arms nozzles clogged</li> <li>5) External Deterget pump worn.</li> <li>6) External Deterget pump faulty.</li> <li>7) Internal Deterget pump worn.</li> <li>8) Internal Deterget pump faulty.</li> <li>9) Wash water temperature not correct</li> <li>10) Boiler water temperature not correct</li> </ol>	<ol style="list-style-type: none"> <li>1) Scrape dishes/glasses before putting them in the basket</li> <li>2) Check the level of detergent aid in the bottle. In case replace the bottle with a new one. <b>It is strongly suggested Electrolux Professional C11 or C13 Detergent aid.</b></li> <li>3) Position the tank cover filter properly</li> <li>4) Clean wash/rinse arms. In case of descaling, please call Service center.</li> <li>5) Please call the service center for chemical products and dispensers</li> <li>6) Please call the service center for chemical products and dispensers</li> <li>7) Please call Service Center</li> <li>8) Please call Service Center</li> <li>9) Please call Service Center</li> <li>10) Please call Service Center</li> </ol>	<ol style="list-style-type: none"> <li>4) Soak Wash/Rinse arms in a solution of water and descale product.</li> <li><b>It is strongly suggested Electrolux Professional Delime away C30.</b></li> <li>7) Replace the peristaltic hose in the detergent pump.</li> <li>8) Replace the detergent pump.</li> <li>9) Set the proper value of tank temperature according to the programming parameters list</li> <li>10) Set the proper value of boiler temperature according to the programming parameters list</li> </ol>

Event number	Anomaly	Type of Anomaly	General description	Possible cause	Instruction to User	Service Action
5	Stained glasses and dishes	Loss of performance	Dishes not cleaned	<ol style="list-style-type: none"> <li>1) Foam in wash/rinse tank</li> <li>2) Internal water softener not regenerated</li> <li>3) Salt bottle for water softener empty</li> <li>4) Internal water softener out of order</li> <li>5) Water hardness out of bounds required</li> <li>6) Wash water temperature not correct</li> </ol>	<ol style="list-style-type: none"> <li>1) Only use "not-foaming" products for professional dishwashers. <b>It is strongly suggested Electrolux Professional C11 or C13 Detergent aid and C12 or C14 Rinse aid.</b></li> <li>2) Start a regeneration cycle after checking the salt bottle is full. In case, ask Service center to provide the spacial salt for water softener.</li> <li>3) Fill the salt bottle. In case, ask Service center to provide the spacial salt for water softener.</li> <li>4) Please call Service Center</li> <li>5) Please call Service Center</li> <li>6) Please call Service Center</li> </ol>	<ol style="list-style-type: none"> <li>2) Provide special salt for internal water softener</li> <li>3) Provide special salt for internal water softener</li> <li>4) Please refer to Event number 18-Water softener out of order.</li> <li>5) Adjust the amount of detergent and rinse aid.</li> <li>6) Set the proper value of tank temperature according to the programming parameters list</li> </ol>
6	Condensation on glasses	Loss of performance	Moisture deposited on the glasses surface	<ol style="list-style-type: none"> <li>1) Dishwasher is running without rinse-aid</li> <li>2) Rinse-aid peristaltic pump faulty</li> </ol>	<ol style="list-style-type: none"> <li>1) Check that there is rinse-aid in the bottle and in case top up. <b>It is strongly suggested Electrolux Professional C12 or C14 Rinse aid.</b></li> <li>2) Please call Service Center</li> </ol>	<ol style="list-style-type: none"> <li>2) Replace rinse aid peristaltic pump</li> </ol>
7	Smears or spots on the glasses	Loss of performance	Smears or spots on the glasses	<ol style="list-style-type: none"> <li>1) Excessive dosage of rinse-aid</li> <li>2) Rinse-aid peristaltic pump faulty</li> </ol>	Please call Service Center	<ol style="list-style-type: none"> <li>1) Reduce the amount of rinse-aid.</li> <li>2) Replace rinse aid peristaltic pump</li> </ol>
8	Glasses and dishes are not dried properly	Loss of performance	Water drops deposited on the glasses surface	<ol style="list-style-type: none"> <li>1) Dishwasher is running without rinse-aid</li> <li>2) Rinse-aid peristaltic pump faulty</li> <li>3) Water rinse temperature too low</li> </ol>	<ol style="list-style-type: none"> <li>1) Check that there is rinse-aid in the bottle and in case top up. <b>It is strongly suggested Electrolux Professional C12 or C14 Rinse aid.</b></li> <li>2) Please call Service Center</li> <li>3) Please call Service Center</li> </ol>	<ol style="list-style-type: none"> <li>2) Replace rinse aid peristaltic pump</li> <li>3) Set the proper value of boiler temperature according to the programming parameters list</li> </ol>
9	Excessive foam in the tank	Loss of performance	Presence of foam over the tank filters	<ol style="list-style-type: none"> <li>1) Residuals of food or detergent used for manual scraping</li> <li>2) Excessive dosage of rinse-aid</li> <li>3) Rinse-aid peristaltic pump faulty</li> <li>4) Wash water temperature not correct</li> </ol>	<ol style="list-style-type: none"> <li>1) Check if the tank has been cleaned with suitable cleaners. In case empty the tank and care-fully rinse before resuming work. If a foaming detergent was used, empty and refill the tank with water until the foam has been removed.</li> <li>2) Please call Service Center</li> <li>3) Please call Service Center</li> <li>4) Please call Service Center</li> </ol>	<ol style="list-style-type: none"> <li>2) Reduce the amount of rinse-aid.</li> <li>3) Replace rinse aid peristaltic pump</li> <li>4) Set the proper value of tank temperature according to the programming parameters list</li> </ol>



Event number	Anomaly	Type of Anomaly	General description	Possible cause	Instruction to User	Service Action
10	Loss of water pressure from wash arm	Loss of performance	Crockery not cleaned	<ol style="list-style-type: none"> <li>1) Tank filter dirty</li> <li>2) Intake wash pump filter dirty</li> <li>3) Obstruction in the pipe inlet/outlet of wash pump</li> <li>4) Wash pump clogged</li> </ol>	<ol style="list-style-type: none"> <li>1) Remove and clean the tank filter</li> <li>2) Remove and clean the wash pump filter</li> <li>3) Please call Service Center</li> <li>4) Please call Service Center</li> </ol>	<ol style="list-style-type: none"> <li>3) Uninstall the inlet and outlet hoses of the pump and check if they are clogged: in case clean the hoses.</li> <li>4) Uninstall the wash pump and check if the impeller is clogged: in case clean the impeller.</li> </ol>
11	Loss of water pressure from rinse arm	Loss of performance	Crockery not rinsed	<ol style="list-style-type: none"> <li>1) Rinse arm clogged</li> <li>2) Filling valve faulty</li> <li>3) Booster pump out of order</li> <li>4) Rinse pump out of order</li> </ol>	<ol style="list-style-type: none"> <li>1) Remove and clean the rinse arm</li> <li>2) Please call Service Center</li> <li>3) Please call Service Center</li> <li>4) Please call Service Center</li> </ol>	<ol style="list-style-type: none"> <li>2) Replace the filling valve</li> <li>3) Please refer to anomaly 16-Booster pump out of order</li> <li>4) Please refer to anomaly 17-Rinse pump out of order</li> </ol>
12	The machine is off but it still fills water in the tank	Loss of performance	Glasswasher is off but does not stop rinsing	<ol style="list-style-type: none"> <li>1) Filling valve faulty</li> <li>2) Cold rinse valve faulty</li> <li>3) Cleaning water softener valve faulty</li> </ol>	Please call Service Center	<ol style="list-style-type: none"> <li>1) Replace the filling valve</li> <li>2) Replace the cold rinse valve</li> <li>3) Replace cleaning water softener valve</li> </ol>
13	Cold rinse cycle does not run	Machine blocked	After the cold rinse cycle crockery are still hot	<ol style="list-style-type: none"> <li>1) Appliance connected to hot water supply</li> <li>2) Cold rinse valve dirty</li> <li>3) Cold rinse valve faulty</li> <li>4) Booster pump out of order</li> <li>5) User interface A2 faulty.</li> <li>6) Main board A1 faulty.</li> </ol>	Please call Service Center	<ol style="list-style-type: none"> <li>1) Connect the appliance to cold water supply</li> <li>2) Remove and clean the cold rinse valve</li> <li>3) Replace the cold rinse valve</li> <li>4) Please refer to anomaly 16-Booster pump out of order</li> <li>5) Replace User interface A2.</li> <li>6) Replace Main board A1.</li> </ol>
14	Wash pump out of order	Machine blocked	Wash arm does not spray water	<ol style="list-style-type: none"> <li>1) Wash pump clogged</li> <li>2) Pump capacitor faulty</li> <li>3) Wash pump faulty</li> <li>4) Main board A1 faulty.</li> </ol>	Please call Service Center	<ol style="list-style-type: none"> <li>1) Remove and clean the wash pump</li> <li>2) Replace the pump capacitor</li> <li>3) Replace the wash pump</li> <li>4) Replace Main board A1.</li> </ol>
15	Drain pump out of order	Loss of performance	Glasswasher cannot be emptied	<ol style="list-style-type: none"> <li>1) Drain pump clogged</li> <li>2) Drain pump faulty</li> <li>3) Main board A1 faulty.</li> </ol>	Please call Service Center	<ol style="list-style-type: none"> <li>1) Remove and clean the drain pump</li> <li>2) Replace the drain pump</li> <li>3) Replace Main board A1.</li> </ol>
16	Booster pump out of order	Loss of performance	Glasswasher cannot rinse	<ol style="list-style-type: none"> <li>1) Booster pump clogged</li> <li>2) Pump capacitor faulty</li> <li>3) Booster pump faulty</li> <li>4) Main board A1 faulty.</li> </ol>	Please call Service Center	<ol style="list-style-type: none"> <li>1) Remove and clean the Booster pump</li> <li>2) Replace the pump capacitor</li> <li>3) Replace Booster pump</li> <li>4) Replace Main board A1.</li> </ol>

Event number	Anomaly	Type of Anomaly	General description	Possible cause	Instruction to User	Service Action
17	Rinse pump out of order	Loss of performance	Glasswasher cannot rinse	1) Rinse pump clogged 2) Pump capacitor faulty 3) Rinse pump faulty 4) Main board A1 faulty.	Please call Service Center	1) Remove and clean the Rinse pump 2) Replace the pump capacitor 3) Replace Rinse pump 4) Replace Main board A1.
18	Water softener out of order	Loss of performance	Water hardness at the exit of water softener is the same as the inlet	1) Water softener regeneration valve faulty 2) Water softener resins exhausted	Please call Service Center	1) Replace the cleaning valve of water softener 2) Replace the water softener.

## 5.2 TROUBLESHOOTING BY CODED ANOMALIES LIST

Based on the severity of the detected issue, the machine behaves in three different ways:

- **Warning:** the issue cannot be solved by the operator and it drives to loss of performance.
- **Alarm:** the issue cannot be solved by the operator and it completely compromises performance or safety.

**Warning** is a minor issue of the machine that typically determines loss of performance.

The main purpose of “Warnings” is to allow machine operates despite some issue occurred.

The machine goes in “**Alarm**” status when a severe error is detected. Once in “Alarm status”, the machine stops completely all the activities.

Event number	Anomaly	Type of Anomaly	General description	Possible cause	Instruction to User	Service Action
A1	Lack of water Water filling system does not run properly or locked	Alarm Blocking	Water supply does not fill boiler within 5 minutes OR tank within 20 minutes	<ol style="list-style-type: none"> <li>1) Customer water supply system does not work.</li> <li>2) Water tap that fills the appliance closed.</li> <li>3) Water supply hose throttled.</li> <li>4) "Y" strainer clogged</li> <li>5) Pressure drop of the water network of the client.</li> <li>6) Overflow not correctly fitted or missing</li> <li>7) The O-ring on the overflow pipe damaged or missing.</li> <li>8) Overflow broken or worn/deformed</li> <li>9) Door switch signal is not activated</li> <li>10) Filling valve dirty</li> <li>11) Filling valve faulty</li> <li>12) Pressure switch for tank level faulty</li> <li>13) User interface A2 faulty.</li> <li>14) Main board A1 faulty.</li> </ol>	<ol style="list-style-type: none"> <li>1) Warn the customer to check if any valves of external water supply is closed.</li> <li>2) Open the water tap.</li> <li>3) Fix up the hose path. In case, call Service Center to replace the hose.</li> <li>4) Remove the filter cartridge from the filter holder and clean it of impurities.</li> <li>5) Check the water pressure of the main water tap. It has to be 1.8 bar at least (1.0 bar atmospheric appliance).</li> <li>6) Check the overflow pipe and insert it correctly in the tank.</li> <li>7) Replace the O-ring. In case, call Service Center to provide a new O-ring.</li> <li>8) Replace the overflow. In case, call Service Center to provide a new overflow.</li> <li>9) Check if the door is closed properly. In case call Service Center.</li> <li>10) Please call Service Center</li> <li>11) Please call Service Center</li> <li>12) Please call Service Center</li> <li>13) Please call Service Center</li> <li>14) Please call Service Center</li> </ol>	<ol style="list-style-type: none"> <li>3) Replace the hose for the water inlet.</li> <li>7) Provide a new spare O-ring for overflow pipe.</li> <li>8) Provide a new overflow pipe</li> <li>9) Replace the door switch</li> <li>10) Remove and clean the filling valve</li> <li>11) Replace the filling valve</li> <li>12) Replace the pressure switch for tank</li> <li>13) Replace User interface A2.</li> <li>14) Replace Main board A1.</li> </ol>
b1	Wash Tank draining timeout expired	Warning Not blocking	The level in the tank does not decrease within 180 seconds when the drain cycle has started.	<ol style="list-style-type: none"> <li>1) Overflow not removed.</li> <li>2) The filter of the wash pump is dirty.</li> <li>3) Airtrap dirty.</li> <li>4) Drainpipe clogged</li> <li>5) Pressure switch does not work properly.</li> <li>6) Pressure switch faulty.</li> <li>7) Airtrap broken.</li> <li>8) Drain pump locked.</li> <li>9) Drain pump faulty.</li> </ol>	<ol style="list-style-type: none"> <li>1) Remove the overflow pipe</li> <li>2) Clean the wash pump filter.</li> <li>3) Clean airtrap</li> <li>4) Please call Service Center</li> <li>5) Please call Service Center</li> <li>6) Please call Service Center</li> <li>7) Please call Service Center</li> <li>8) Please call Service Center</li> <li>9) Please call Service Center</li> </ol>	<ol style="list-style-type: none"> <li>4) Clean drainpipe</li> <li>5) Check the plastic tube between pressure switch and air trap:                         <ul style="list-style-type: none"> <li>-it must not contain water; disconnect the tube and gently blow compressed air into it</li> <li>-it must not be throttled; disconnect the tube and connect it again in a proper way, eliminating the choke point.</li> <li>-it must not be broken in case, replace the tube.</li> </ul> </li> <li>6) Replace airtrap.</li> <li>7) Replace pressure switch.</li> <li>8) Remove the drain pump and clean it.</li> <li>9) Replace the drain pump.</li> </ol>

Event number	Anomaly	Type of Anomaly	General description	Possible cause	Instruction to User	Service Action
<b>b2</b>	Wash Tank level too high, risk of overflow	Warning Not blocking	Overflow contact P2 of the pressure switch enabled	<ol style="list-style-type: none"> <li>1) The filter of the wash tank is dirty.</li> <li>2) Airtrap dirty.</li> <li>3) Overflow pipe clogged</li> <li>4) Drainpipe clogged</li> <li>5) Pressure switch faulty</li> <li>6) Filling valve stuck open or faulty</li> <li>7) Main board A1 faulty</li> </ol>	<ol style="list-style-type: none"> <li>1) Clean the wash tank filter.</li> <li>2) Clean the airtrap.</li> <li>3) Clean the overflow pipe</li> <li>4) Please call Service Center</li> <li>5) Please call Service Center</li> <li>6) Please call Service Center</li> <li>7) Please call Service Center</li> </ol>	<ol style="list-style-type: none"> <li>4) Clean drainpipe</li> <li>5) Replace pressure switch.</li> <li>6) Replace filling valve.</li> <li>7) Replace main board A1.</li> </ol>
<b>C1</b>	Boiler empty	Warning Not blocking	The temperature trend is higher than expected. Condition: Boiler heating element R2 ON.	<ol style="list-style-type: none"> <li>1) Boiler temperature probe NT1 do not work properly</li> <li>2) Leakage on the hydraulic circuit that fills the boiler.</li> <li>3) Leakage from devices assembled with the boiler.</li> </ol>	Please call Service Center	<ol style="list-style-type: none"> <li>1) Replace tank temperature probe NT1</li> <li>2) Check if the hoses connected to the boiler are well fixed by clamps.</li> <li>3) Check if the temp. probe NT1 is well fixed. Check if the heating element R2 is well fixed and the gasket is properly placed on the resistors flange.</li> </ol>
<b>C2</b>	Boiler over-temperature	Warning Not blocking	The temperature in the boiler is too high; risk of damages. The temperature is higher than bHI for 3 seconds. This parameter is in the Factory parameters.	<ol style="list-style-type: none"> <li>1) Wrong parameters set</li> <li>2) Boiler temperature probe NT1 does not work properly</li> <li>3) The relays RL2/3/4 on Main board A1 board are stuck</li> </ol>	Please call Service Center	<ol style="list-style-type: none"> <li>1) Set up the proper values for the parameters according to parameters list.</li> <li>2) Replace tank temperature probe NT1</li> <li>3) Replace main board A1</li> </ol>
<b>C3</b>	Tank water over-temperature	Warning Not blocking	The temperature in the tank is too high; risk of damages. The temperature is higher than tHI for 3 seconds. This parameter is in the Factory parameters.	<ol style="list-style-type: none"> <li>1) Wrong parameters set</li> <li>2) Tank temperature probe NT2 does not work properly</li> <li>3) The relay RL5 on Main board A1 board is stuck</li> </ol>	Please call Service Center	<ol style="list-style-type: none"> <li>1) Set up the proper values for the parameters according to parameters list.</li> <li>2) Replace tank temperature probe NT2</li> <li>3) Replace main board A1</li> </ol>
<b>C4</b>	Tank temp. probe disconnected	Warning Not blocking	Electronics detects tank temperature probe NT2 open for 3 seconds .	<ol style="list-style-type: none"> <li>1) Temperature probe NT2 is unplugged.</li> <li>2) Temperature probe NT2 connector is not inserted correctly</li> <li>3) The connector CN5 of Main board A1 is unplugged.</li> <li>4) Temperature probe NT2 faulty.</li> </ol>	Please call Service Center	<ol style="list-style-type: none"> <li>1) Reconnect Temperature probe NT2</li> <li>2) Reconnect Temperature probe NT2</li> <li>3) Reconnect connector CN5 to Main board A1</li> <li>4) Replace Temperature probe NT2</li> </ol>
<b>C5</b>	Tank temp. probe short circuit	Warning Not blocking	Electronics detects tank temperature probe NT2 short for 3 seconds .	Temperature probe NT2 faulty	Please call Service Center	Replace Temperature probe NT2

Event number	Anomaly	Type of Anomaly	General description	Possible cause	Instruction to User	Service Action
C6	Boiler temp. probe disconnected	Warning Not blocking	Electronics detects boiler temperature probe NT1 open for 3 seconds .	1) Temperature probe NT1 is unplugged. 2) Temperature probe NT1 connector is not inserted correctly 3) The connector CN5 of Main board A1 is unplugged. 4) Temperature probe NT1 faulty.	Please call Service Center	1) Reconnect Temperature probe NT1 2) Reconnect Temperature probe NT1 3) Reconnect connector CN5 to Main board A1 4) Replace Temperature probe NT1
C7	Boiler temp. probe short circuit	Warning Not blocking	Electronics detects boiler temperature probe NT1 short for 3 seconds .	Temperature probe NT1 faulty	Please call Service Center	Replace Temperature probe NT1
C8	Rinsing is not done regularly for 2 consecutive cycles	Alarm Blocking	Appliance equipped with atmospheric boiler. After 2 consecutive cycles, the control system cannot see level decrease in the boiler.	1) Rinse arms clogged 2) Rinse pump out of order 3) Water in the slim tube from boiler airtrap to Main board A1 4) Boiler level sensor integrated in the Main board A1 faulty	Please call Service Center	1) Soak Wash/Rinse arms in a solution of water and descale product. It is strongly suggested Electrolux Professional Delime away C30. 2) Please refer to anomaly 17-Rinse pump out of order in the General troubleshooting. 3) Empty the boiler, remove the slim tube and blow getly into it in order to drain any trace of water inside. Restore the slim tube at last. 4) Replace Main board A1 WARNING! RESETTING THIS ALARM WITHOUT FIRST ELIMINATING THE CAUSE IS DANGEROUS; THE BOILER HEATING ELEMENTS COULD WORK DRY, FURTHER DAMAGING THE INTERNAL PARTS OF THE DISHWASHER. ATTENTION: ALARM C8 MUST BE MANUALLY RESET AFTER ELIMINATING THE CAUSE OF THE MALFUNCTION. PLEASE REFER TO INFORMATION AT PAG 37 ABOUT HOW RESET THE ALARM.
E1	Communication error	Warning Not blocking	No communication between Main board A1 and User interface A2	1) Connector CN16 on User Interface A2 not properly connected 1) Connector CN12 on Main board A1 not properly connected 3) Main board A1 faulty. 4) User interface A2 faulty.	Please call Service Center	1) Fix the connector CN16 to User interface A2. 2) Fix the connector CN12 to Main board A1. 3) Replace Main board A1. 4) Replace User interface A2.

Event number	Anomaly	Type of Anomaly	General description	Possible cause	Instruction to User	Service Action
E2	Tank temperature too low	Warning Not blocking	During tank warm-up, temperature must increase at least 1.0 °C. This parameter is in the Factory parameters.	1) Wrong parameters set 2) Tank temperature probe NT2 does not work properly 3) Pressure switch faulty 4) The tank heating element R1 does not work properly 5) The Relay R1 faulty	Please call Service Center	1) Set up the proper values for the parameters according to parameters list. 2) Replace tank temperature probe NT2 3) Replace the pressure switch 4) Replace the tank heating element R1 5) Replace Main board A1.
E3	Boiler temperature too low	Warning Not blocking	During boiler warm-up, temperature must increase at least 1.0 °C. This parameter is in the Factory parameters. <b>ATTENTION:</b> When a branch of the heating element does not work and the other two continue to operate, on reaching the set temperature value, alarm E3 disappears but reappears in the next rinse phase; this also happens when a phase is lacking.	1) Wrong parameters set 2) Boiler temperature probe NT1 does not work properly 3) The tank heating element R2 does not work properly 4) One of relays R2/R3/R4 faulty	Please call Service Center	1) Set up the proper values for the parameters according to parameters list. 2) Replace boiler temperature probe NT1 3) Replace the tank heating element R2 4) Replace Main board A1.
F21	Water softener operation errors (Only for water softener Double skin Undercounter Range)	Warning Not blocking	Malfunctioning of the continuous water softener.	Enter in the error parameters family and check the sub-menu errors list of F21	To reset error F21 it is necessary to disconnect and reconnect the main power supply to the machine by means of the main switch on the external power board. Please call Service Center	To reset error F21 it is necessary to disconnect and reconnect the main power supply to the machine by means of the main switch on the external power board.
F21_1	Water softener conductivity sensor short-circuit	Warning Not blocking	Malfunctioning of the continuous water softener.	Two or more water softener conductivity sensors are short-circuited	Please call Service Center	Check the connections between the water softener board and sensors, replacing the connection wiring if necessary.
F21_2	Water softener conductivity sensors open	Warning Not blocking	Malfunctioning of the continuous water softener.	One or more water softener conductivity sensors are disconnected	Please call Service Center	Check the connections between the water softener board and sensors, replacing the connection wiring if necessary.
F21_3	Resin temperature sensor malfunction	Warning Not blocking	Malfunctioning of the continuous water softener.	Water softener electronic board fault	Please call Service Center	Replace the water softener electronic board.

Event number	Anomaly	Type of Anomaly	General description	Possible cause	Instruction to User	Service Action
<b>F21_4</b>	Water softener electronic board malfunction	Warning Not blocking	Malfunctioning of the continuous water softener.	Water softener electronic board fault	Please call Service Center	Replace the water softener electronic board.
<b>F21_9</b>	Salt water filling malfunction	Warning Not blocking	The salt water container in the water softener is not completely filled within the set max. filling time.	<ol style="list-style-type: none"> <li>1) the water tap is not open</li> <li>2) the feed water pressure is under 50 kPa / 0.5 bar</li> <li>3) the salt container cap is not properly closed</li> <li>4) the grid on the bottom of the salt container is clogged with dirt</li> <li>5) the water inlet filter is not clean</li> <li>6) the filling solenoid valve filter is not clean</li> <li>7) the water filling solenoid valve does not work correctly</li> <li>8) the salt container solenoid valve does not work correctly</li> <li>9) the mother board (ATM-PRES) connector CN2 is not correctly positioned</li> <li>10) the water softener board connector ST5 is not correctly positioned</li> </ol>	<ol style="list-style-type: none"> <li>1) open the main water tap</li> <li>2) Verify the water pressure of the water supply network. If it is too low, a pressure booster pump is required</li> <li>3) close properly the salt container cap</li> <li>4) clean the grid on the bottom of the salt container</li> <li>5) open the "Y" strainer if present, and clean the mesh inside</li> <li>6) Please call Service Center</li> <li>7) Please call Service Center</li> <li>8) Please call Service Center</li> <li>9) Please call Service Center</li> <li>10) Please call Service Center</li> </ol>	<ol style="list-style-type: none"> <li>6) clean the filter inside the filling solenoid valve</li> <li>7) replace the filling solenoid valve</li> <li>8) replace the water softener</li> <li>9) fit properly connector CN2 on the mother board (ATM-PRES)</li> <li>10) fit properly connector ST5 on the water softener board</li> </ol>
<b>F21_10</b>	Inefficient resin washing	Warning Not blocking	After carrying out the maximum permissible number of resin washes, the resins are not sufficiently cleaned by the salt water used to regenerate them.	<ol style="list-style-type: none"> <li>1) the feed water pressure is under 50 kPa / 0.5 bar</li> <li>2) the water inlet filter is not clean</li> <li>3) the filling solenoid valve filter is not clean</li> <li>4) the water filling solenoid valve does not work correctly</li> <li>5) the mother board (ATM-PRES) connector CN2 is not correctly positioned</li> </ol>	<ol style="list-style-type: none"> <li>1) Verify the water pressure of the water supply network. If it is too low, a pressure booster pump is required</li> <li>2) open the "Y" strainer if present, and clean the mesh inside</li> <li>3) Please call Service Center</li> <li>4) Please call Service Center</li> <li>5) Please call Service Center</li> </ol>	<ol style="list-style-type: none"> <li>3) clean the filter inside the filling solenoid valve</li> <li>4) replace the filling solenoid valve</li> <li>5) fit properly connector CN2 on the mother board (ATM-PRES)</li> </ol>
<b>F22</b>	Communication errors between the mother board and softener board (Only for water softener Double skin Undercounter Range)	Warning Not blocking	Communication errors between the mother board and softener board	No connection between the mother board and water softener board.	Please call Service Center	Check the connection between mother board connector J1 and water softener connector ST8



## 6 SERVICING THE APPLIANCE

---

### 6.1 LIST OF NEEDED TOOLS

Please, refer to the Electrolux Professional Universal Spare Parts Catalogue [USP].

#### 6.1.1 Ordinary tools

The following tools take part of the Kit of assorted tools [USP #0S1288] contained in the Tool trolley case [USP #0S1980]:

- Phillips and Flat screwdriver.
- Ratchet wrench M7 or Socket wrenches M7.
- Ratchet wrench M8 or Socket wrenches M8.
- Ratchet wrench M10 or Socket wrenches M10.
- Ratchet wrench M13 or Socket wrenches M13.

#### 6.1.2 Special tools

In addition to the normal instrumentation, to do the maintenance of this unit the following tools are recommended:

- Digital multimeter [USP #0S1282].
- Current clamp [USP #0S1456].
- Digital thermometer [USP #0S0838] + water immersion-penetration probe [usp #0S1158].
- Water pressure gauge [USP #0S0478].
- Water analysis case [USP #0S0483].

### 6.2 COMPONENTS REPLACEMENT – SINGLE SKIN UNDERCOUNTER

This chapter explains how to remove various parts of the equipment to access its functional components: please always refer to this guide to access various parts.



**DANGER!** Before any operation on the machine read chapter 1.2 SAFETY INFORMATION/PRECAUTIONS.



**DANGER!** Before doing any work on the equipment ALWAYS unplug it from the power supply (danger of fatal electric shock!).

To reinstall a part, follow the instructions in reverse order to those described below.

## 6.2.1 Components layout for single skin undercounter

Pos.	Component
------	-----------

- B1** Door
- B2** Mainboard
- B3** Salt container
- B4** Boiler heating element
- B5** Boiler temperature sensor
- B6** Tank heating element
- B7** Boiler
- B8** Tank sensor
- B9** Clixson tank heting element
- B10** Wash pump
- B11** Drain mainfold
- B12** Rinse pump
- B13** Loading solenoid valve
- B14** Lower Jet support
- B15** Air gap
- B16** Water softener
- B17** Pump rinse aid
- B18** Pressure switch
- B19** User interface
- B20** Door micro switch

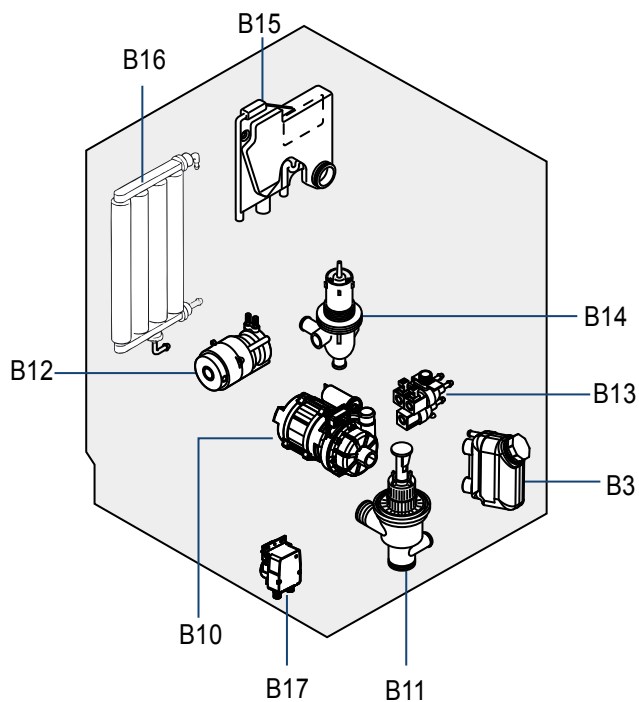
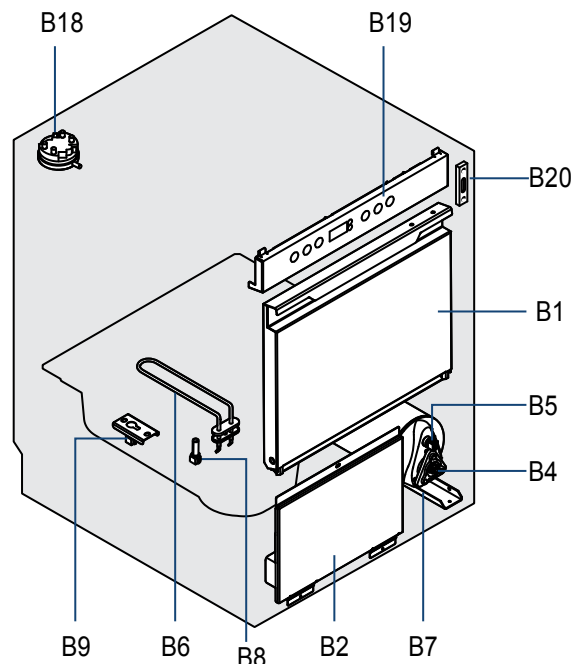

### 6.2.2 Door B1 replacement

- 1) Open the door
- 2) Remove the seger left and right of arms support ( pic.1)
- 3) Unscrews the left and right hinges bolts (pic. 2)
- 4) Pull out the door
- 5) The components, as pins, hinges and seger they are all removed (pic.3 and 4)
- 6) Reinstall all components using the revers procedure ,and use a tightening torque appropriate.

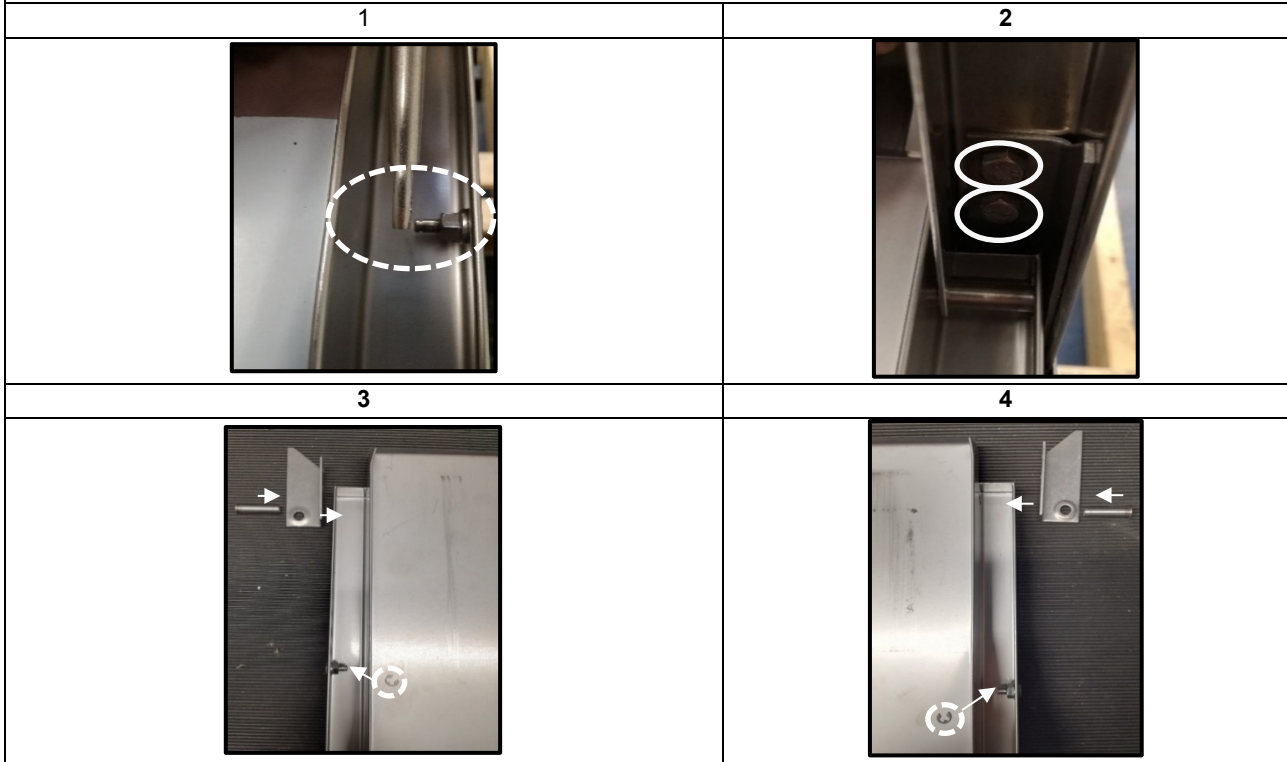

### 6.2.3 Access to front components

- 1) Disconnect the the power supply and close the water supply
- 2) Remove the plug salt if is installed (pic.1)
- 3) Remove the two screws in the bottom front panel (pic.2)
- 4) Pull out and lift the front panel (pic 3)
- 5) The front component will be access
- 6) Reinstall all components using the revers procedure ,and use a tightening torque appropriate

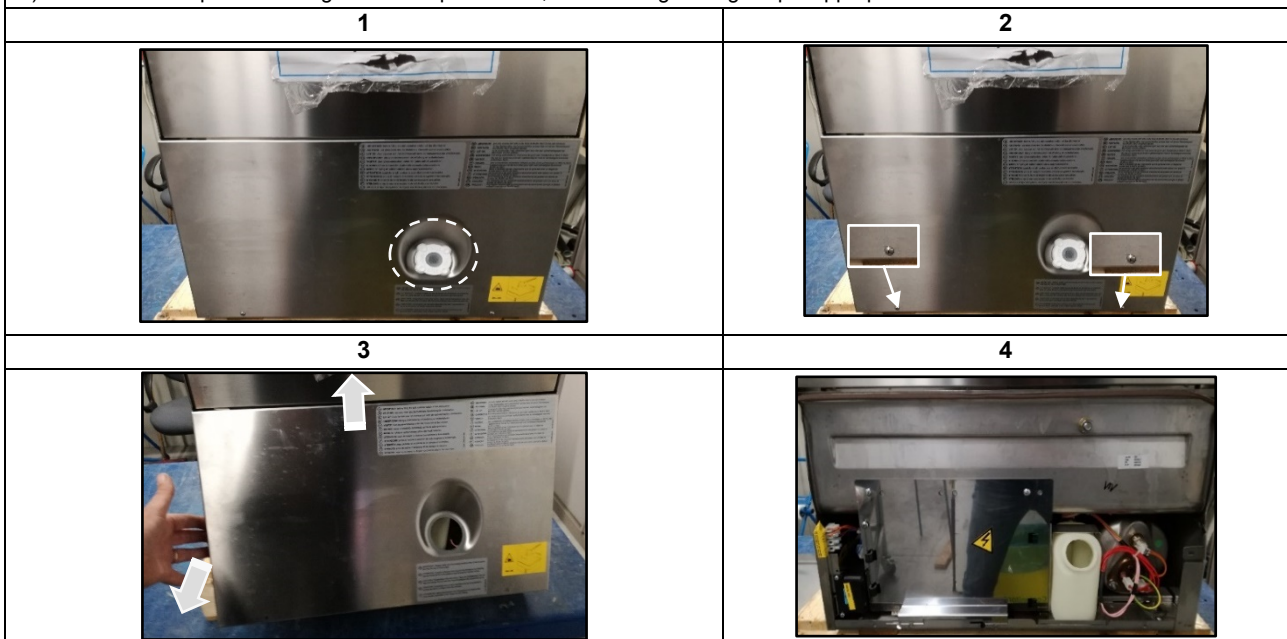

## 6.2.4 Main board B2 replacement

- 1) Following the instruction paragraph 6.2.3 (access to front components)
- 2) Remove two bolt of the support main board (pic.1)
- 3) Pull down the support main board (pic 2 and 3)
- 4) Remove the connectors of main board
- 5) Press the two pins in the left position of main board and pull up all main board (pic 4)
- 6) Reinstall all components using the revers procedure ,and use a tightening torque appropriate

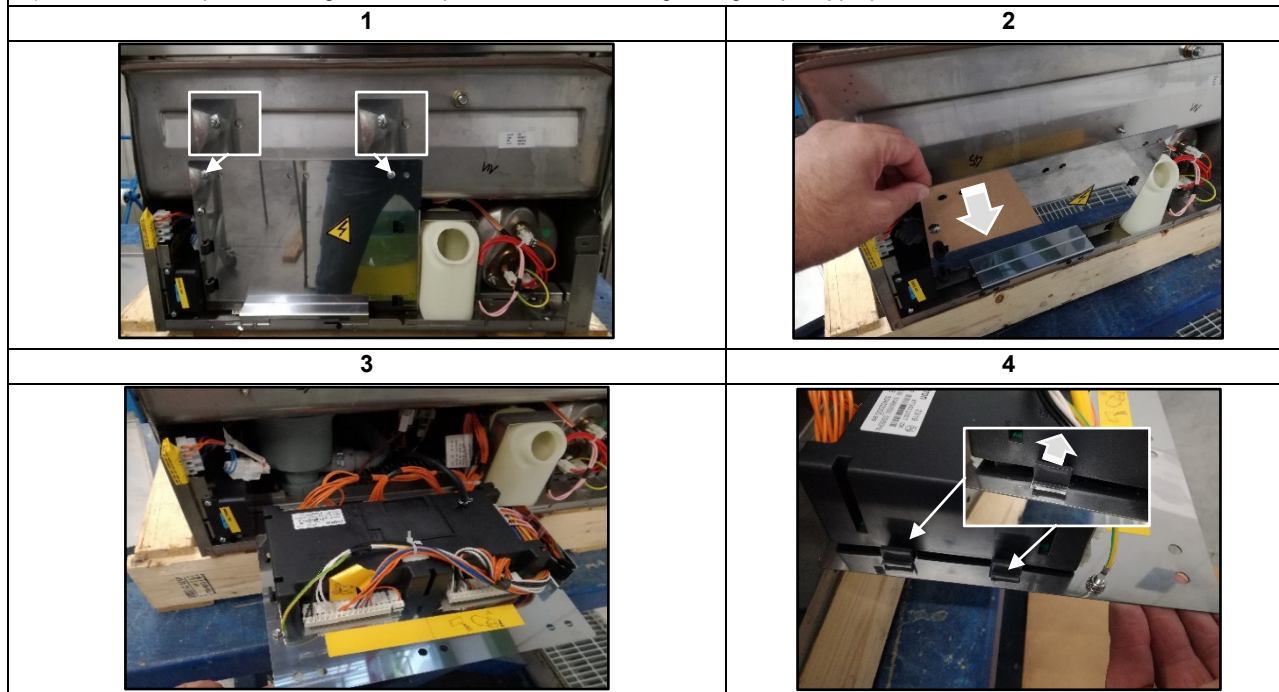

## 6.2.5 Salt container B3 replacement

- 1) Following the instruction paragraph 6.2.3 (access to front components)
- 2) Following the instruction paragraph 6.2.4 (access to Main board) up to point 3
- 3) Remove two bolts ( left and right) that fix the salt container (pic 1)
- 4) Reinstall all components using the revers procedure ,and use a tightening torque appropriate

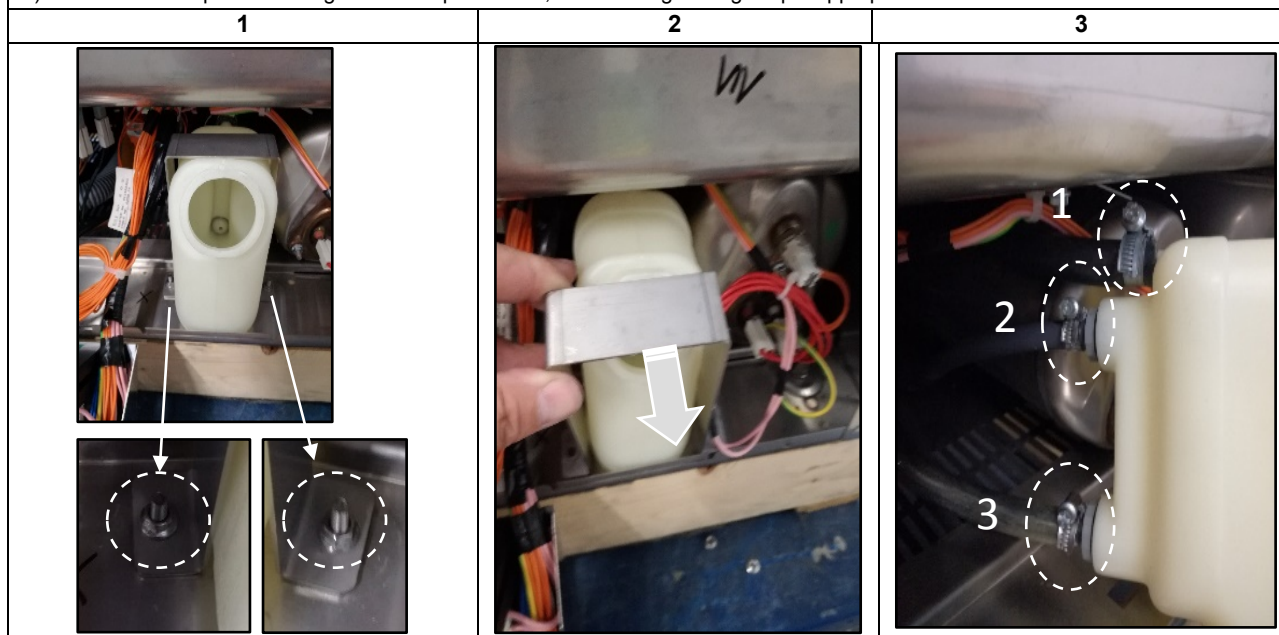

## 6.2.6 Boiler heating element B4 replacement

- 1) Following the instruction paragraph 6.2.3 (access to front components)
- 2) Remove the wiring connector present in the boiler heating element (pic1)
- 3) Remove the three bolts that fix the boiler heating element ( pic 2)



**Attention! Water may be present inside the boiler! The presence of water can damage other nearby components in case of direct contact**

- 4) Pull Out the boiler heating element
- 5) Attention in case of replacement, that the Oring is present in the heating element (pic.4)
- 6) Reinstall all components using the revers procedure ,and use a tightening torque appropriate

1



2



3



4

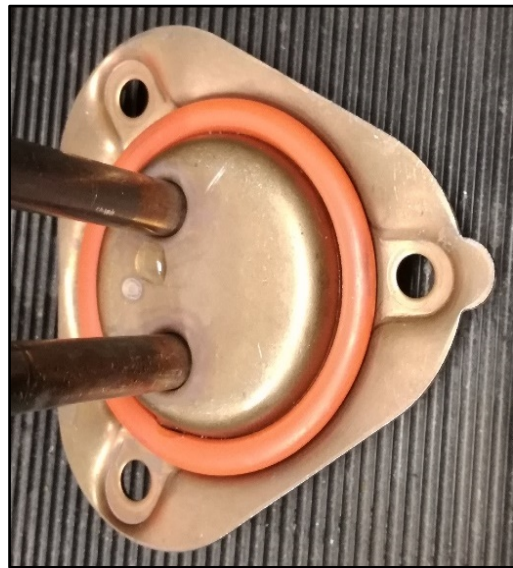

## 6.2.7 Boiler temperature sensor B5 replacement

- 1) Following the instruction paragraph 6.2.3 (access to front components)
- 2) Remove the wiring connector present in the boiler temperature sensor (pic1)
- 3) Unscrew the boiler temperature sensor using an appropriate tools (pic 1)



**Attention! Water may be present inside the boiler! The presence of water can damage other nearby components in case of direct contact**

- 4) Pull Out the boiler temperature sensor from to boiler (pic 2)
- 5) Attention in case of replacement, replace also the Oring in the boiler temperature sensor (pic.3)
- 6) Reinstall all components using the revers procedure ,and use a tightening torque appropriate

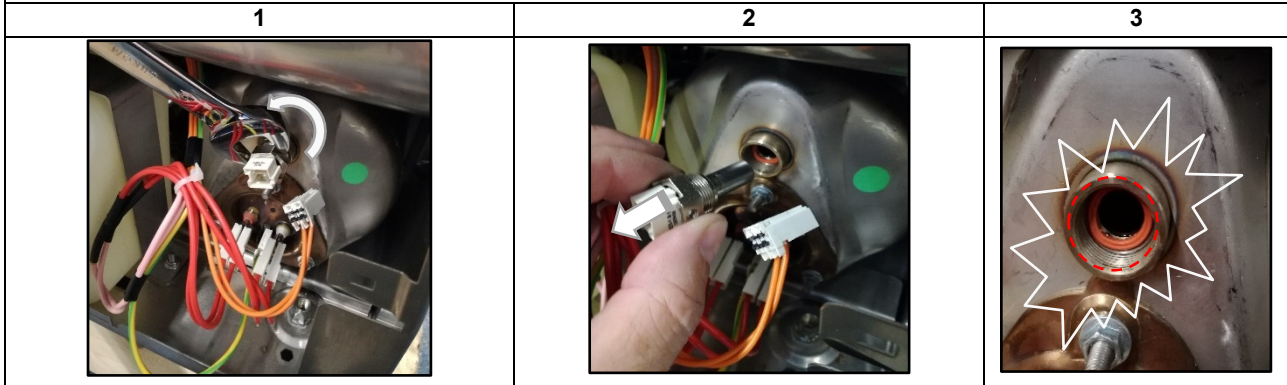

## 6.2.8 Tank heating element B6 replacement

- 1) Following the instruction paragraph 6.2.3 (access to front components)
- 2) Open the door and remove the basket inside ( pic1)
- 3) Remove the wiring connector in the tank heating element (pic. 2)
- 4) Remove the nut that fix the GRD wiring (pic.3)
- 5) Remove the rubber protection present in the tank heating element (pic.4)
- 6) Remove the nut and bottom stopper that fix the tank heating element (pic.5)
- 7) Remove the stopper inside of cavity that fix the tank heating element (pic.6)
- 8) Pull out the tank heating element (pic.7)
- 9) Reinstall all components using the revers procedure ,and use a tightening torque appropriate

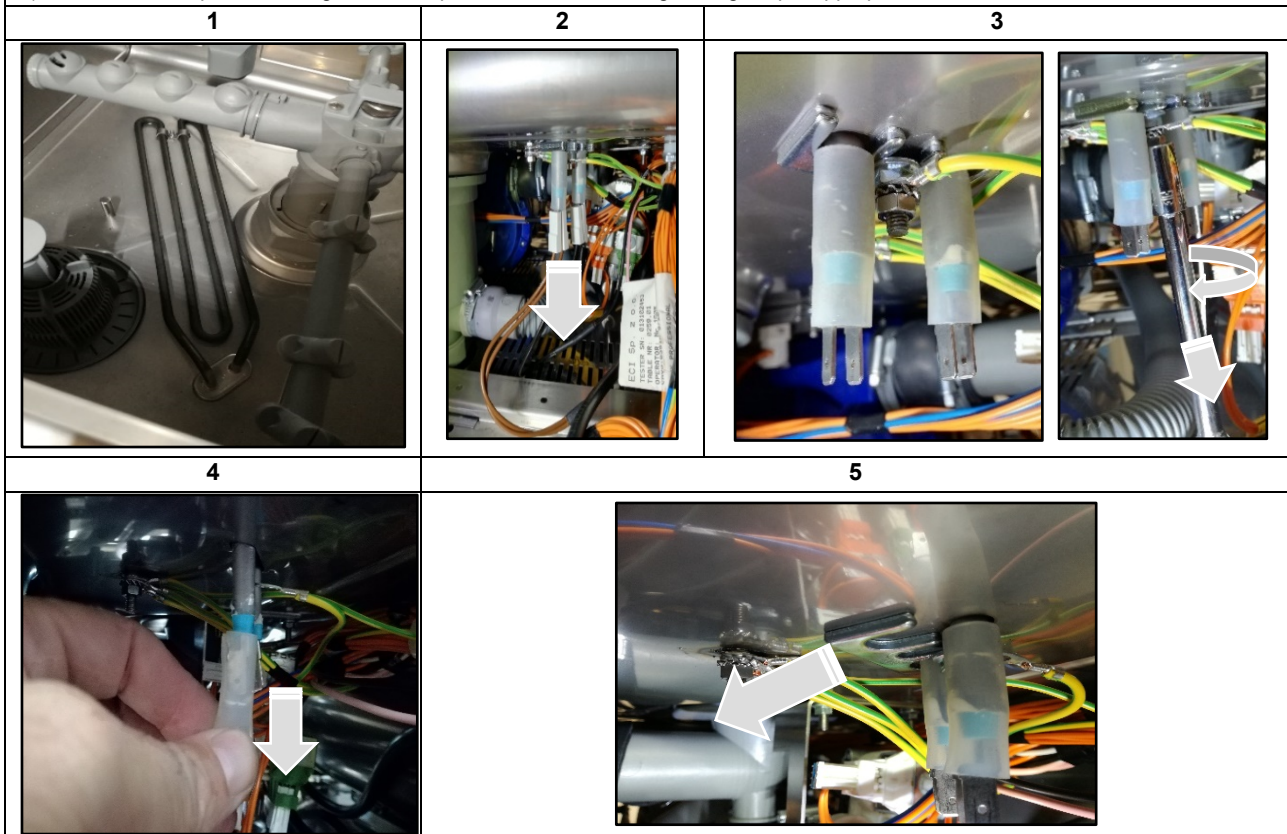

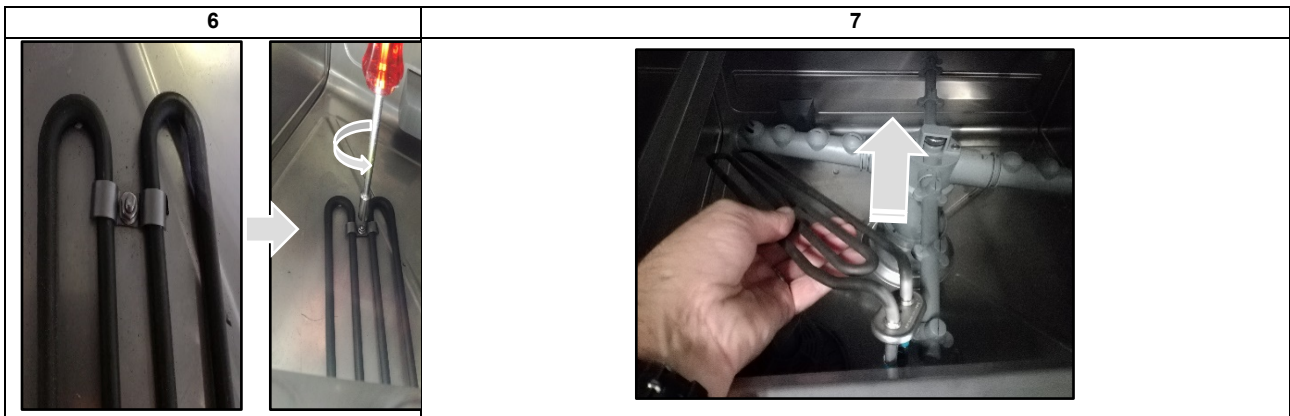

### 6.2.9 Access to back components

- 1) Disconnect the the power supply and close the water supply
- 2) In the back part of the unit remove all connections as: pipes, and electrical power if connected
- 3) Unscrews 4 screws that fix the back panel (pic 2)
- 4) Remove the wiring ground cable
- 5) Open the back panel protections, and disconnect the connector in the clamp (pic 4)
- 6) Take out the back panel
- 7) Reinstall all components using the revers procedure ,and use a tightening torque appropriate

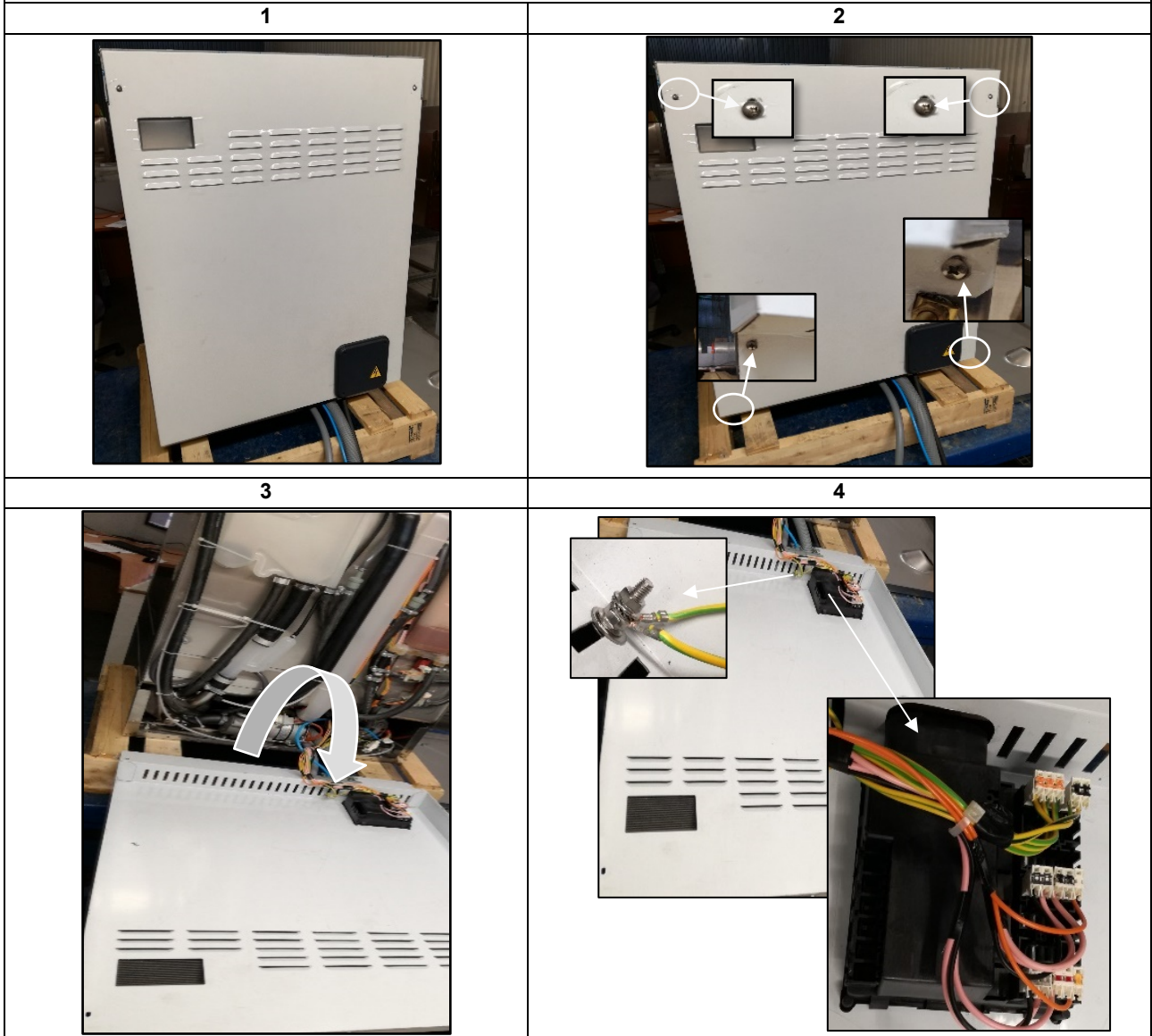

## 6.2.10 Boiler B7 replacement

- 1) Follow the instruction paragraph 6.2.3 (access to front components)
- 2) Remove the wiring connector present in the boiler heating element (pic1)
- 3) Following the instruction paragraph 6.2.9 (access to back components)
- 4) Remove the metallic strip that fix the rubber pipe to the Boiler (pic 2)
- 5) Remove the rubber pipe from the boiler (pic 3 and 4)
- 6) Overtun left or inclination unit till to access to the bottom panel
- 7) Unscrew two screws in the upper part of the bottom panel that fix the boiler to support (pic 4)
- 8) Pull Out the boiler from back part (pic /)



**Attention! Water may be present inside the boiler! The presence of water can damage other nearby components in case of direct contact,**

- 9) Reinstall all components using the revers procedure ,and use a tightening torque appropriate

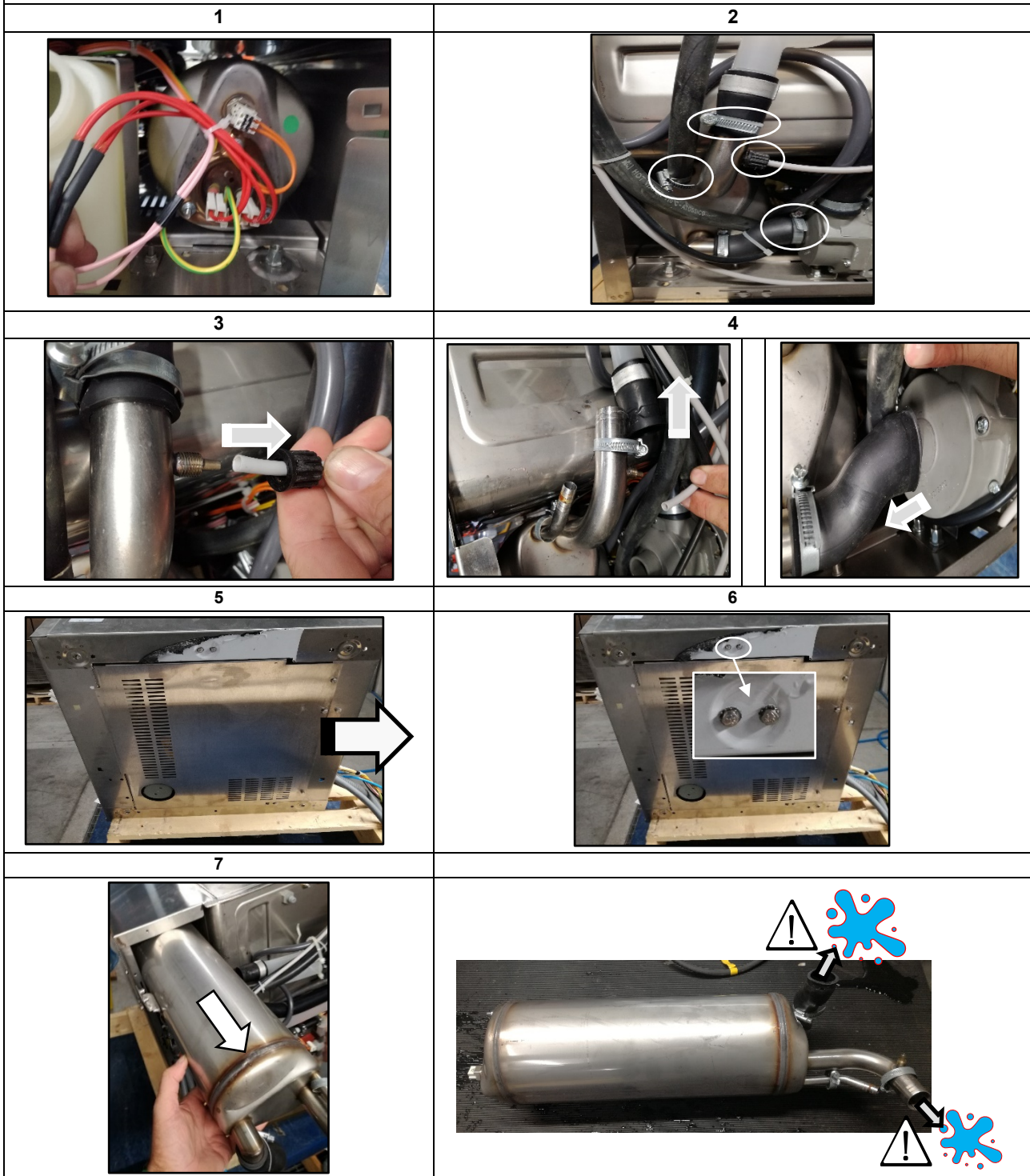



**6.2.11 Tank temperature sensor B8 replacement**

- 1) Overtun left or inclination unit till to access to the bottom panel
  - 2) Unscrews two screws of the bottom panel , and pull towards the right
  - 3) Identification the position of tank sensor in the bottom part of the unit
  - 4) Disconnect the wiring cable
  - 5) Remove two nut that fix the tank sensor plate
  - 6) Pull out the sensor
- ⚠ Attention** in case of replacement, that the Oring is present in the heating element (pic.4)
- 7) Reinstall all components using the revers procedure ,and use a tightening torque appropriate

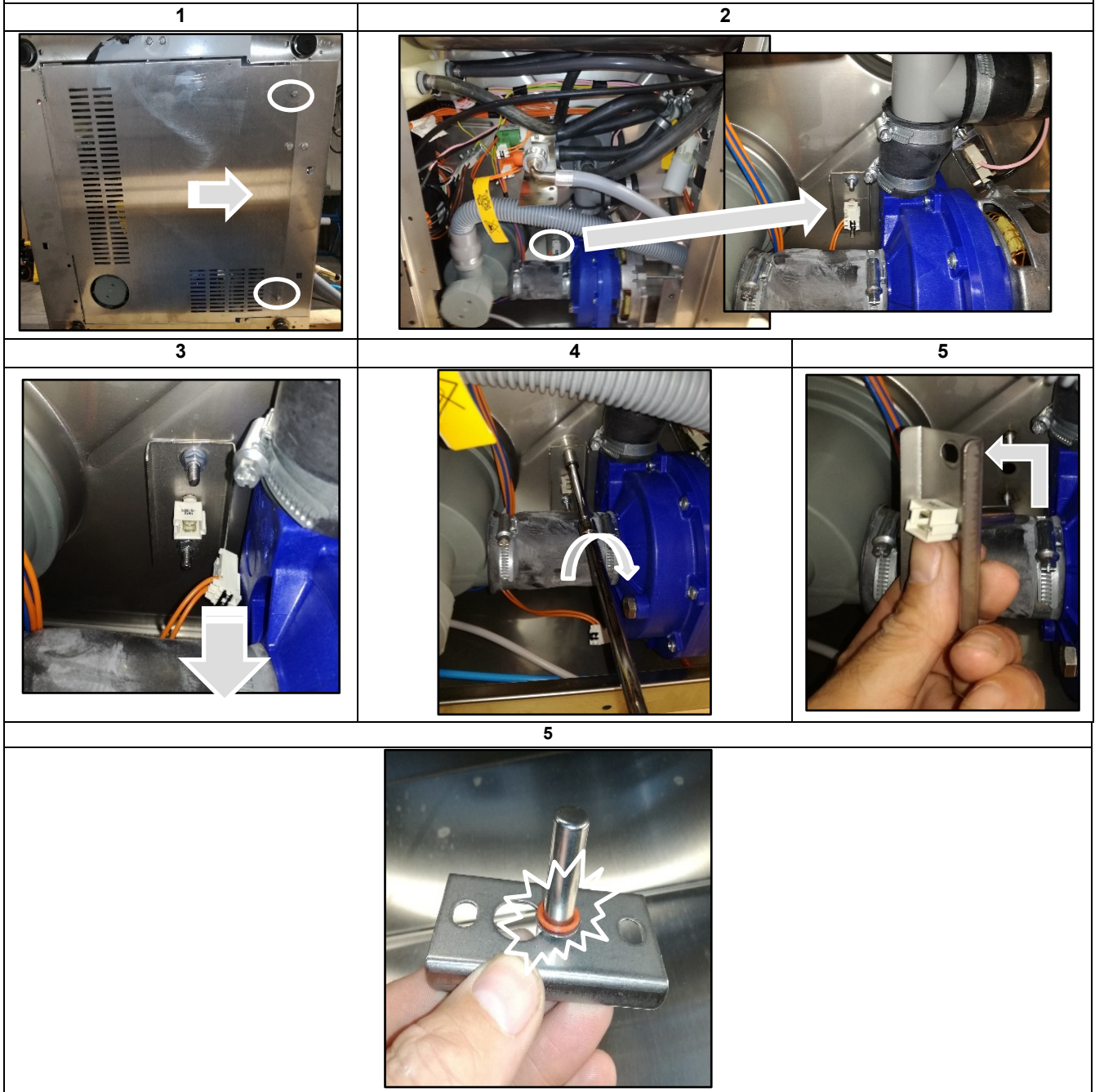

## 6.2.12 Clixson tank heating element B9 replacement

- 1) Follow the instruction paragraph 6.2.9 (access to back components)
- 2) Overtun left or inclination unit till to access to the bottom panel (pic1)
- 3) Unscrews two screws of the bottom panel , and pull towards the right (pic.1)
- 4) Identification the position of the clixson in the bottom part of the unit (pic 2)
- 5) Disconnect the wiring cable (pic 3)
- 6) Remove one left nuts that fix the tank sensor plate (pic 4)
- 7) Unscrew the second nut that fix the tank sensor plate , without remove completely
- 8) Turn tu right the plate support and remove the sensor (pic 5)
- 9) Pull out the clixson (pic.6)
- 10) Reinstall all components using the revers procedure ,and use a tightening torque appropriate

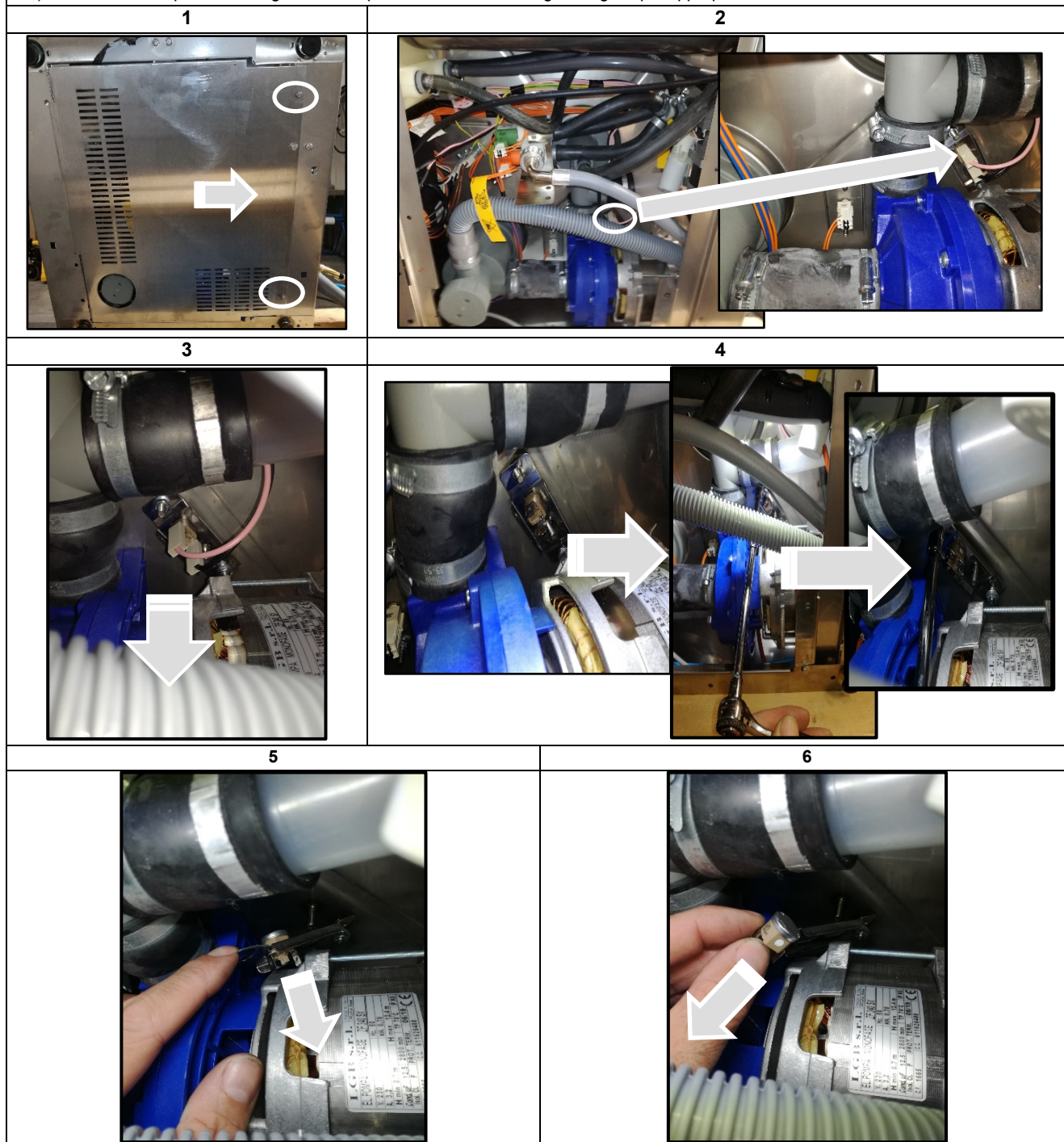

## 6.2.13 Wash pump B10 replacement

- 1) Follow the instructions in paragraph 6.2.9 (access to rear components)
- 2) Tilt or lean the unit to the left until you reach the bottom panel (Fig. 1).
- 3) Unscrew two screws of the bottom panel and pull to the right (fig.1).
- 4) Identify the position of the washing pump at the bottom of the unit (fig. 2).
- 5) Unscrew the fixing clamps that fix the rubber fittings (horizontal and vertical) in the washing pump (fig.3 and 4).
- 6) Move the clamp towards the center of the rubber fitting ( fig.5).
- 7) Disconnect the feed connector of the wash pump
- 8) Remove the screws that secure the pump bracket support on the bottom (fig. 6).
- 9) Remove two screws securing the pump wash bracket (Fig. 7).
- 10) Remove the wash pump bracket (Fig. 8).
- 11) Move the wash pump to the right and remove the rubber hose (Fig. 9\_10).
- 12) Turn the wash pump to the right and pull it out (Fig. 11).
- 13) Before reinstalling a new pump, it is recommended to use new rubber hose fittings and to facilitate insertion use oil for insertion or unscrewing.
- 14) Reinstall all components using the reversing procedure and use a suitable tightening torque.



8



9

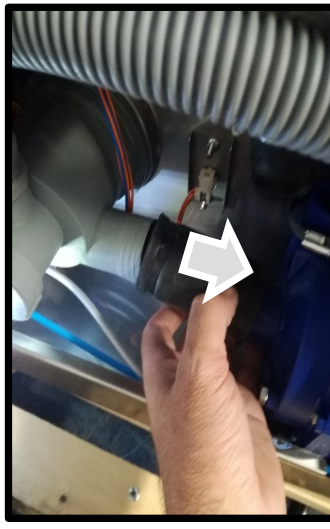

10

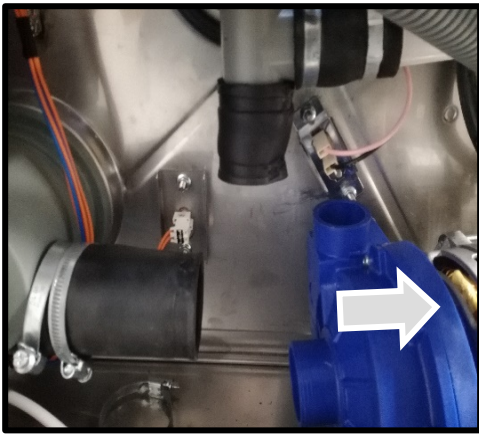

11

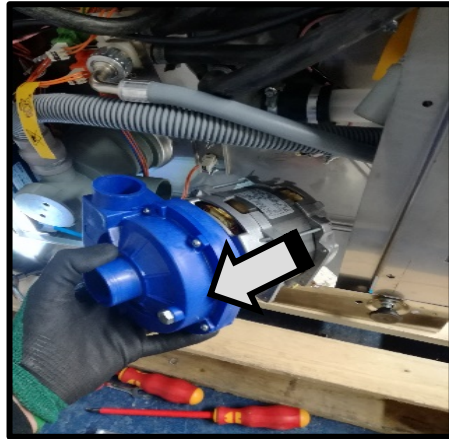

12



## 6.2.14 Drain manifold tank B11 replacement

- 1) Follow the instructions in paragraph 6.2.9 (access to rear components)
  - 2) Follow the instruction paragraph 6.2.3 (access to front components)
  - 3) Remove the components inside of tank as fig 2 overflow "A", the tank filter "B", and the flat filters fig"C" and "D"
  - 4) Tilt or lean the unit to the left until you reach the bottom panel (fig. 1).
  - 5) Unscrew two screws of the bottom panel and pull to the right (fig.1).
  - 6) Identify the position of the discharge cover filter tank in the bottom of the unit (fig. 3).
  - 7) Unscrew the fixing clamps that fix the rubber plumb fittings (horizontal and vertical) in the washing pump and in the discharge cover filter (fig.4).
  - 8) Remove the screws that secure the pump bracket support on the bottom (fig. 5).
  - 9) Remove two screws securing the pump wash bracket (Fig. 7).
  - 10) Move the clamp towards the center of the plumb rubber fitting and let free the discharge cover filter and discharge pump from the plumb rubber (fig.7\_8).
  - 11) Turn to left the cover filter tank, using an appropriate tools, till to remove the plastic nut that fix the filter cover discharge in the wash tank.
  - 12) Remove the tank filter from bottom part
- ⚠ Attention** in case of replacement, that the Oring is present in the heating element (pic.13)
- 13) Before reinstalling a new pump, it is recommended to use new rubber hose fittings and to facilitate insertion use oil for insertion or unscrewing.
  - 14) Reinstall all components using the reversing procedure and use a suitable tightening torque.

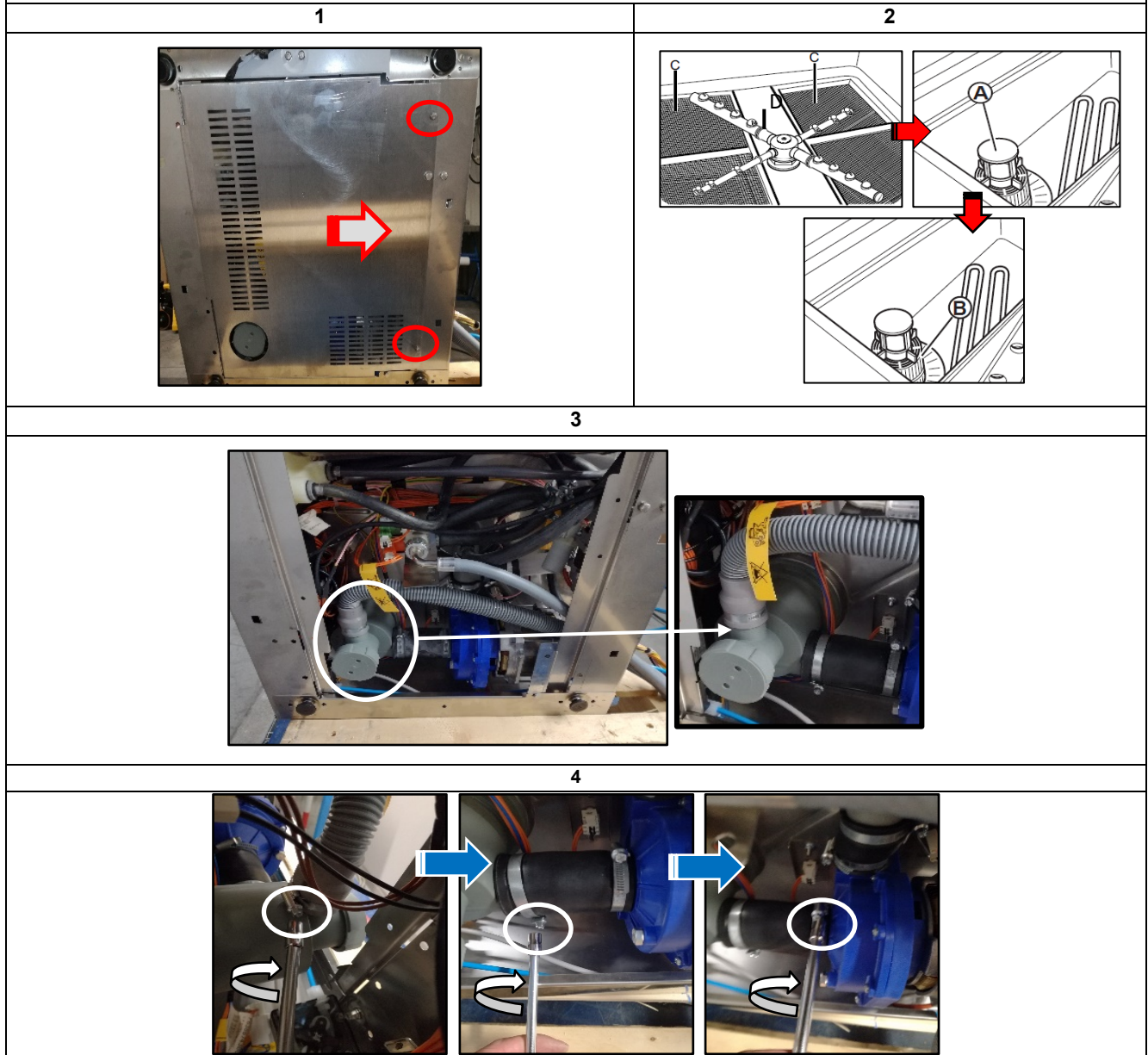

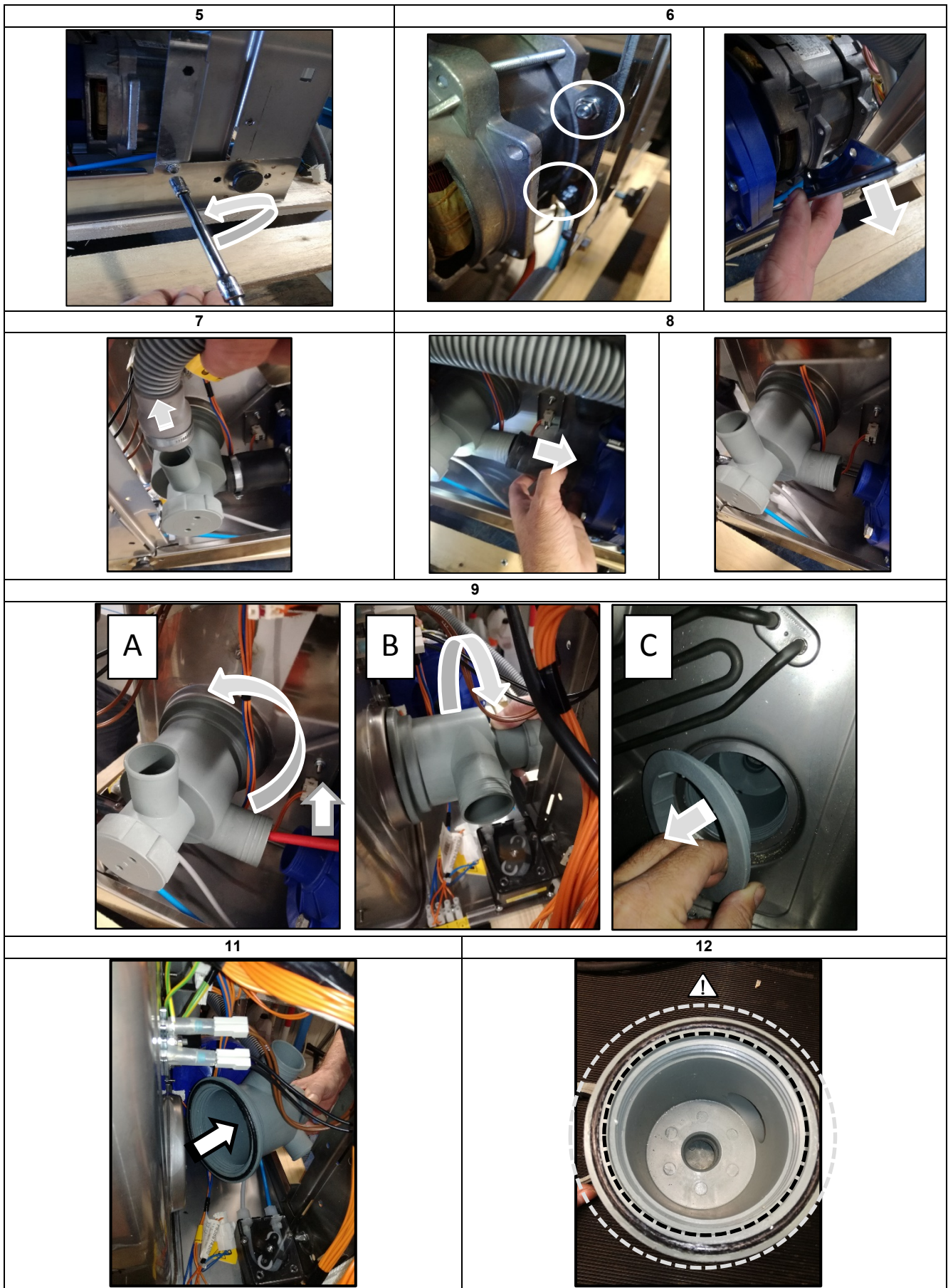

## 6.2.15 Rinse pump B12 replacement

- 1) Follow the instructions in paragraph 6.2.9 (access to rear components)
- 2) Tilt or lean the unit to the left until you reach the bottom panel (Fig. 1).
- 3) Unscrew two screws of the bottom panel and pull to the right (fig.1).
- 4) Identify the position of the boost pump in the bottom of the unit (fig. 2).
- 5) Unscrew the fixing clamps that fix the rubber plumb fittings (horizontal and vertical) (fig.3\_4)
- 6) Disconnect the power connector from the boost pump (fig.5)
- 7) Unscrews the two screws that fix the boost pump to bottom support (Fig.6)
- 8) Extract the boost pump from its position and then remove the top rubber plumb (fig.7)
- 9) When replacing the booster pump, be sure to refit the mounting bracket in the correct position as shown in Figure 8.
- 10) Reinstall all components using the reversing procedure and use a suitable tightening torque.

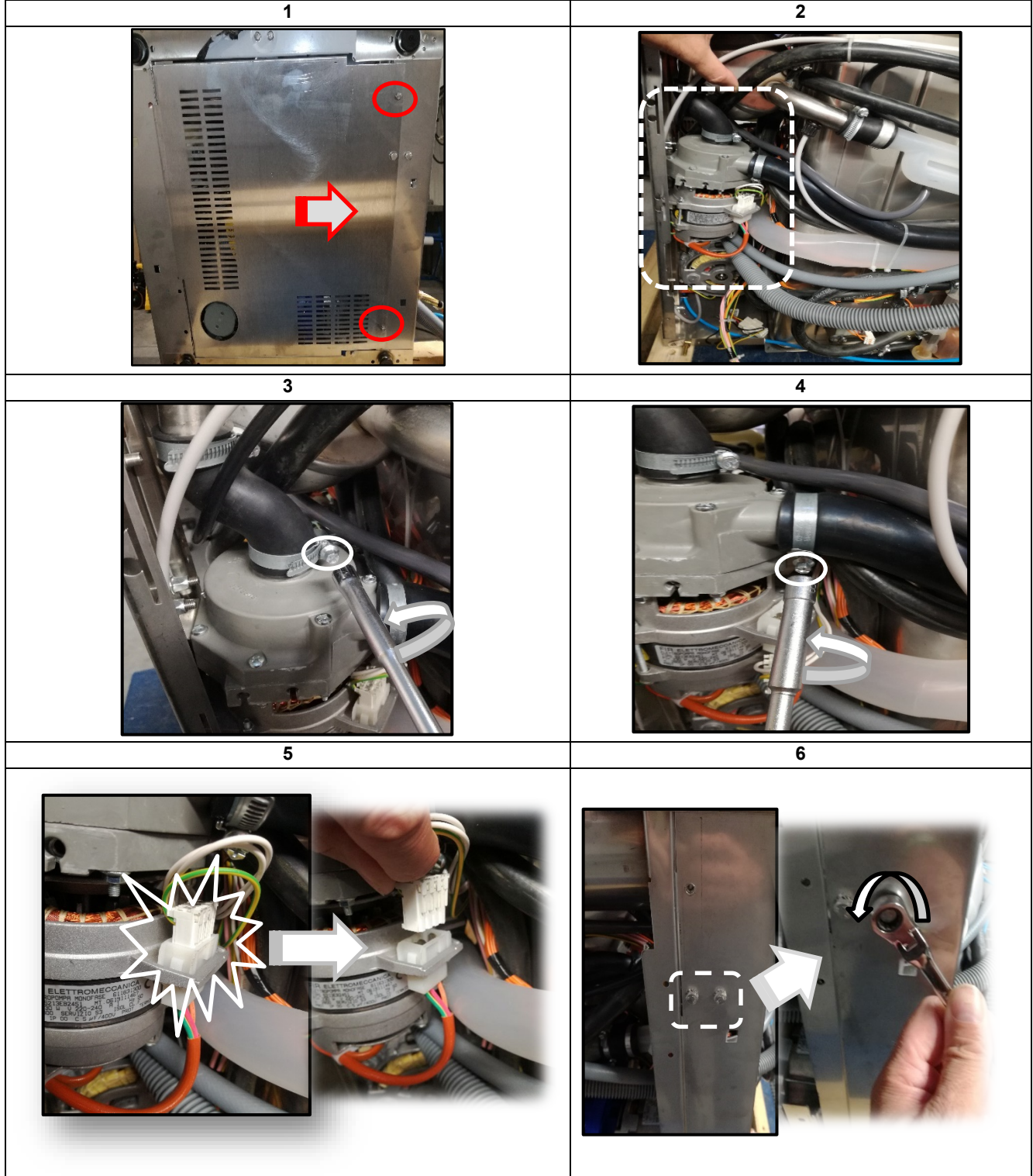

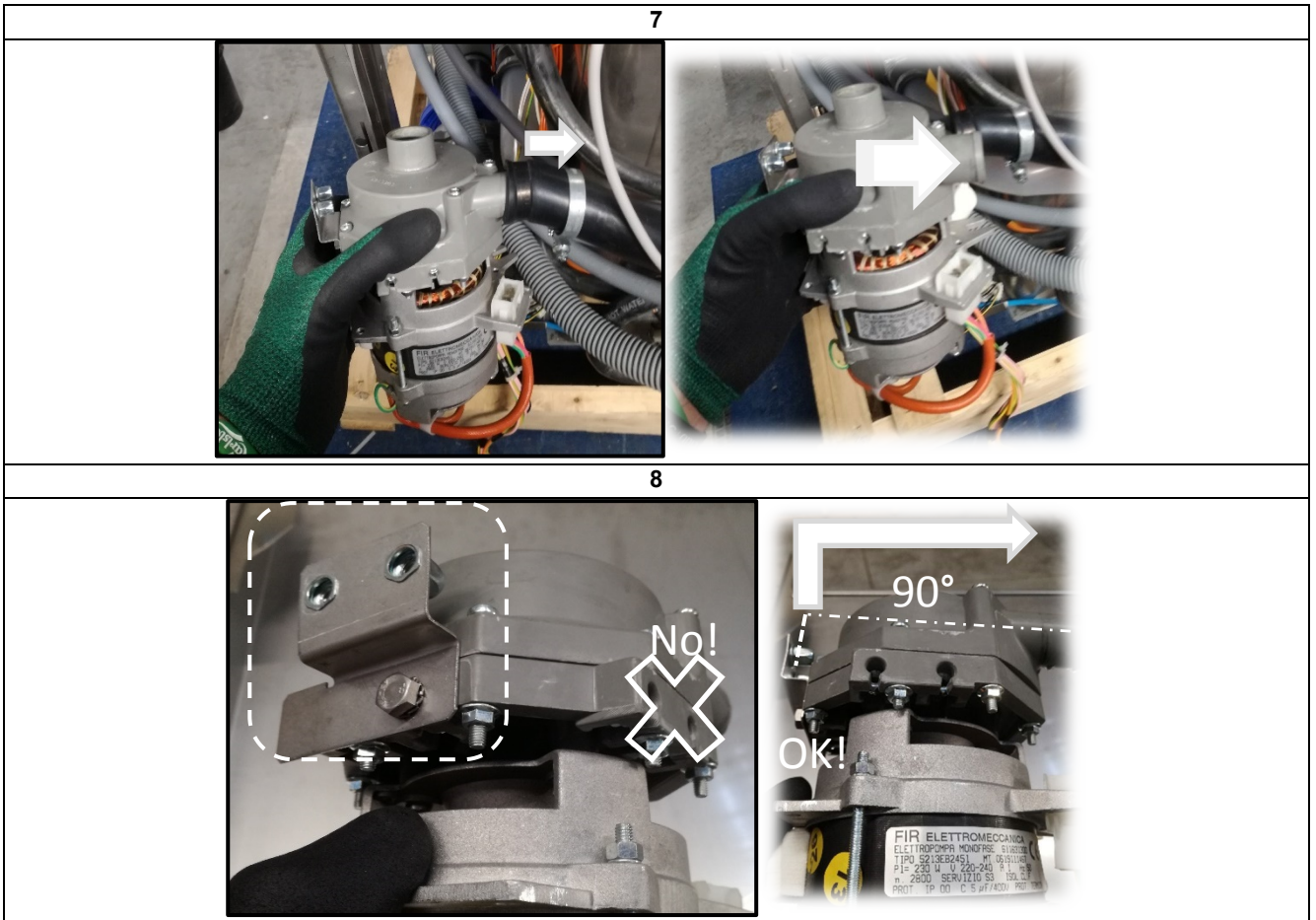

## 6.2.16 Loading solenoid valve B13 replacement

- 1) Follow the instructions in paragraph 6.2.9 (access to rear components)
- 2) Tilt or lean the unit to the left until you reach the bottom panel (Fig. 1).
- 3) Unscrew two screws of the bottom panel and pull to the right (fig.1).
- 4) Identify the position of the loading solenoid valve in the bottom of the unit (fig. 2).
- 5) Close the water supply.
- 6) Unscrew the water loading hose.(fig 3)
- 7) Store the position of the connectors in the load solenoid valve.( To facilitate correct position each connector is identified with a different colors. (fig.5)
- 8) Remove connectors from load solenoid valve.(fig.6)
- 9) Move the solenoid valve to the left, until it comes out of its holder (fig.7)
- 10) Unscrew the metal bands from the rubber hoses (fig.8)
- 11) Remove the rubber hoses from the connection in the solenoid valve, marking their position for easy mounting.
- 12) Reinstall all components using the reversing procedure and use a suitable tightening torque.

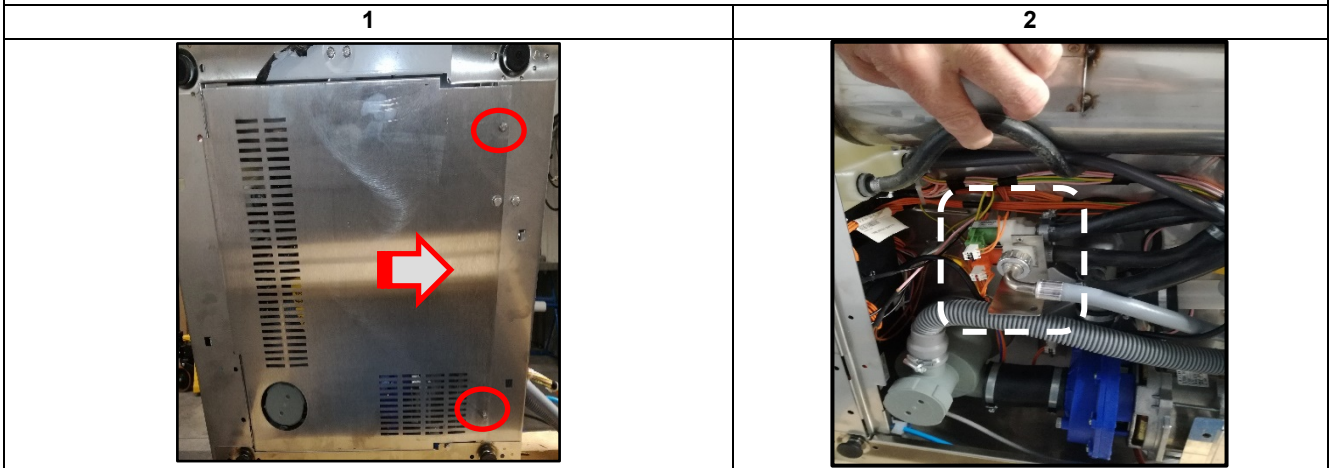



3

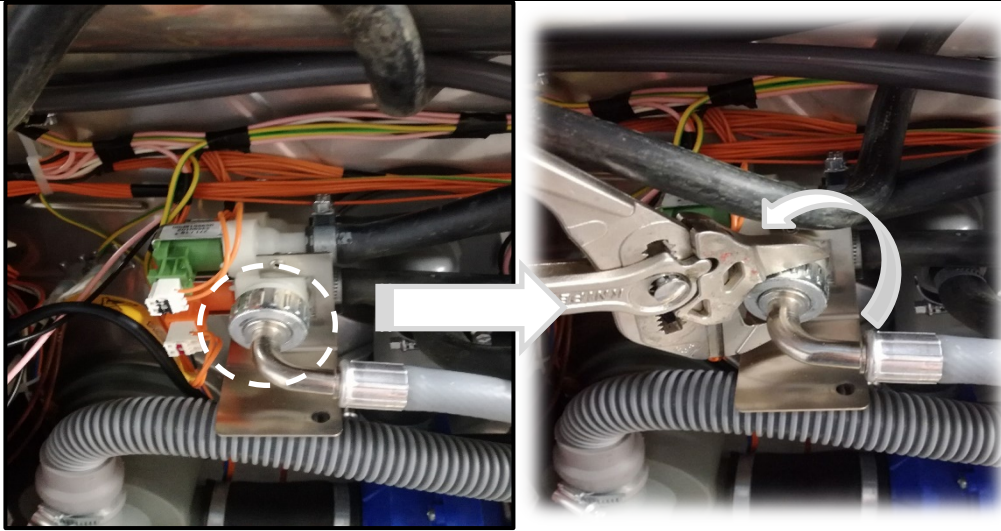

5

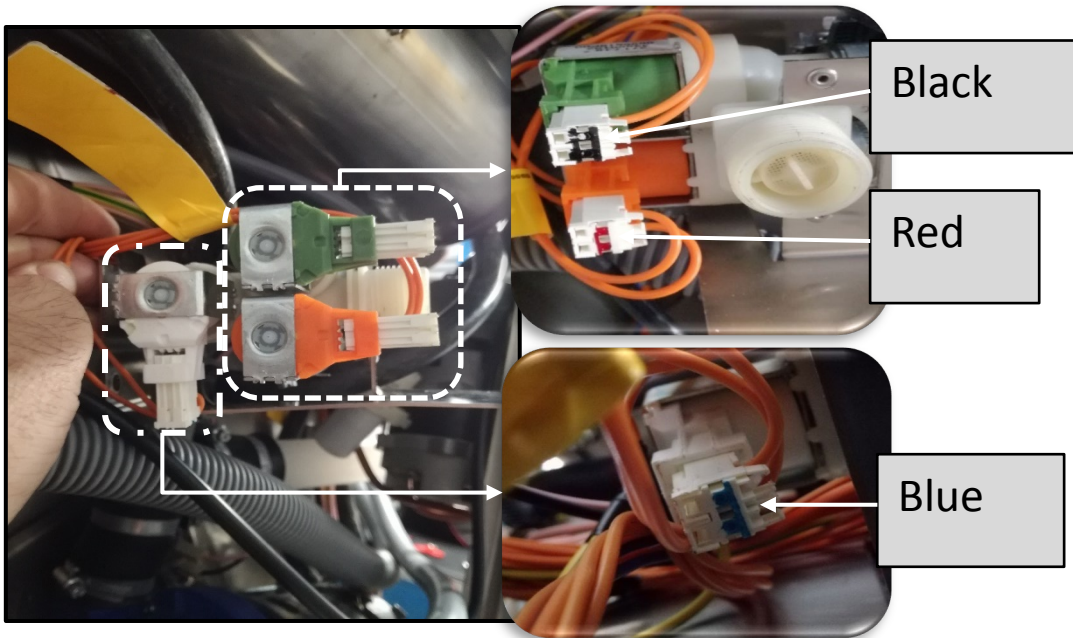

6

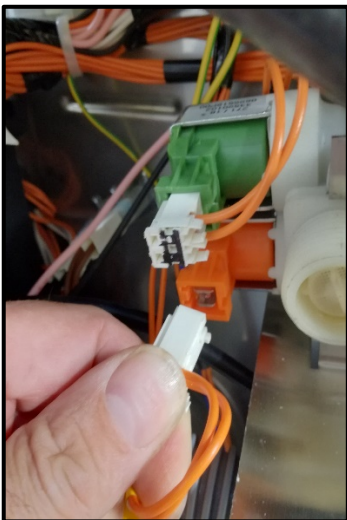

7

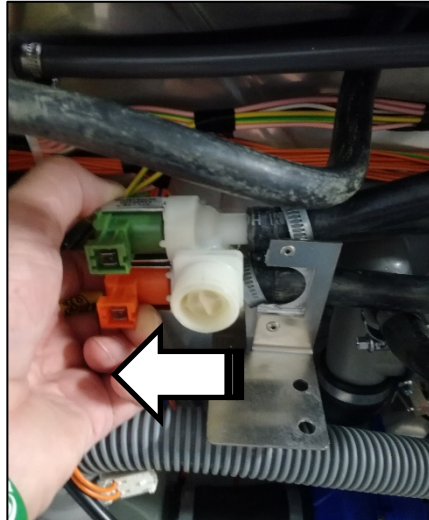

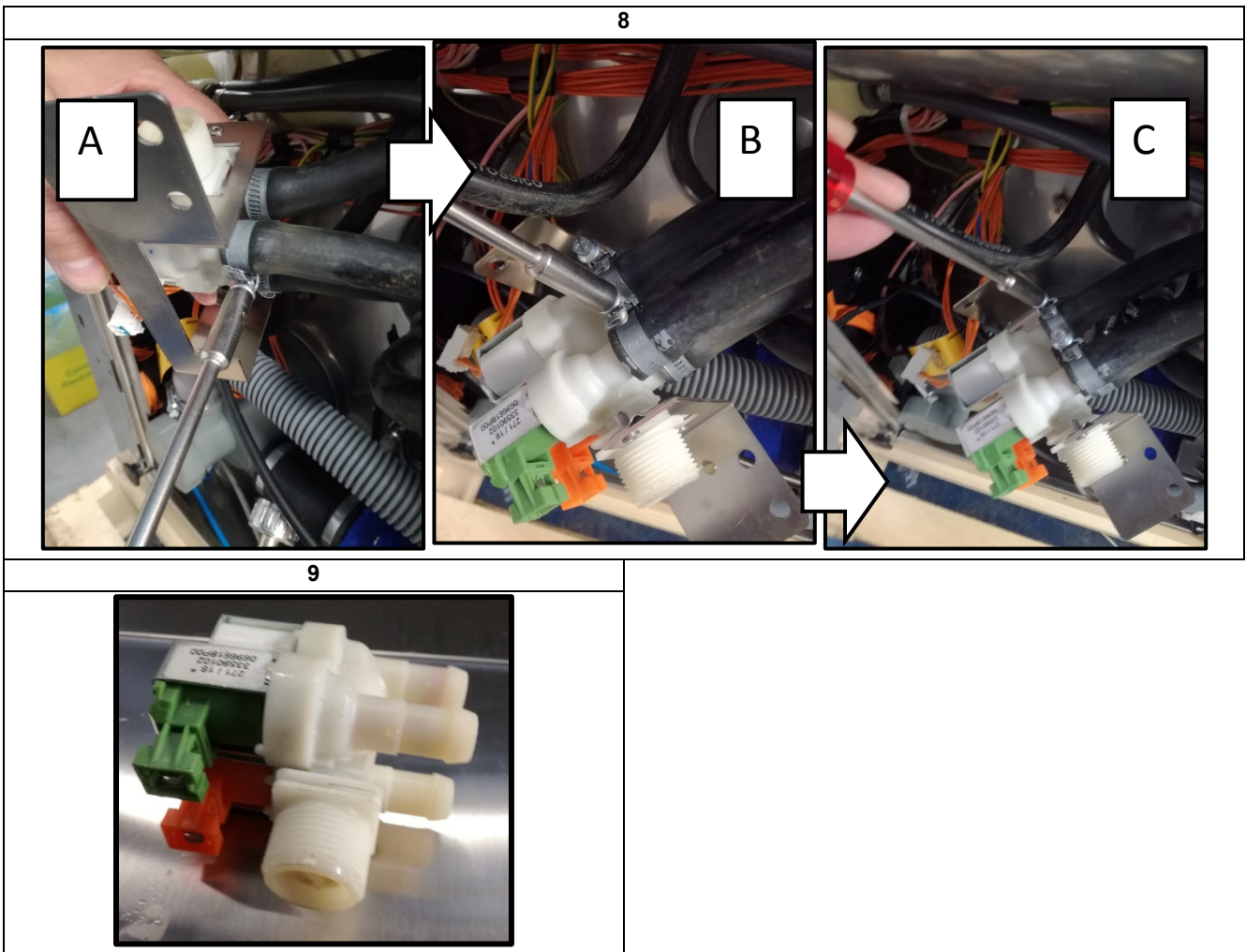

## 6.2.17 Lower Jet support B14 replacement

- 1) Follow the instructions in paragraph 6.2.9 (access to rear components)
- 2) Tilt or lean the unit to the left until you reach the bottom panel (Fig. 1).
- 3) Unscrew two screws of the bottom panel and pull to the right (fig.1).
- 4) Identify the position of the lower jet support in the bottom of the unit (fig. 2).
- 5) Follow the instruction paragraph 6.2.16 up to 5 to 9
- 6) Remove complete lower hub assembly for jet and ring nut jet support locking (Fig.3\_4)
- 7) Unscrew the metal bands from the rubber hoses (fig.5)
- 8) Remove the screws that secure the pump bracket support on the bottom (fig. 6).
- 9) Pull the upper jet connection tube to the right (fig.7)
- 10) Pull out the connection to the pump from the rubber fitting (fig 8)
- 11) Pull out the rubber hose that enters from the bottom of the jet support
- 12) Pay attention to the seals in the component jet.
- 13) Reinstall all components using the reversing procedure and use a suitable tightening torque.

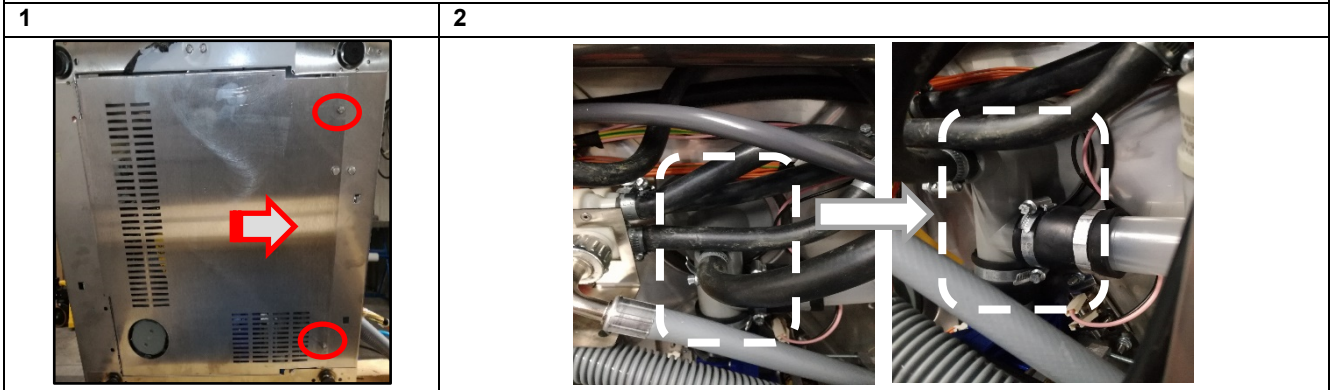

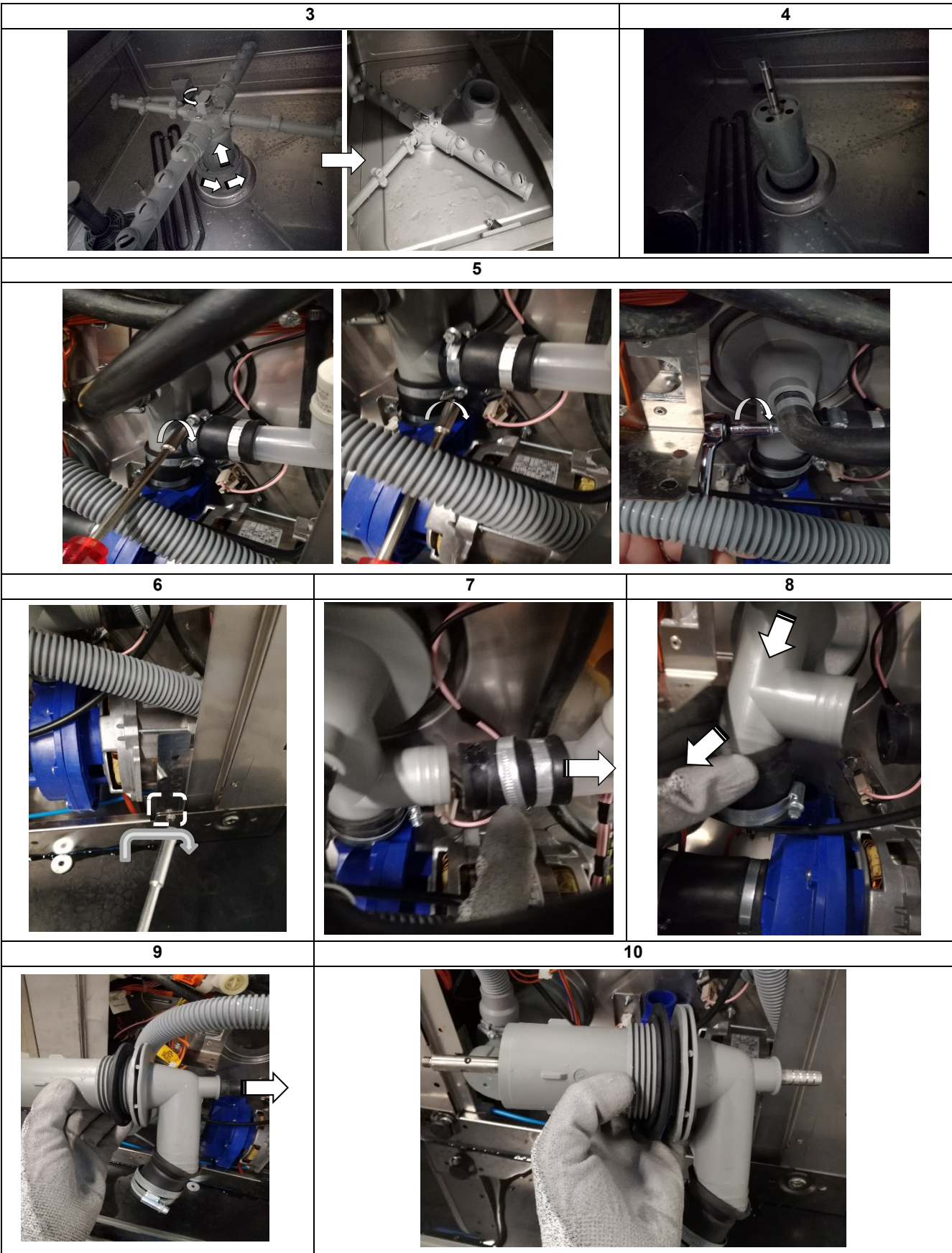

## 6.2.18 Air gap B15 replacement

- 1) Follow the instructions in paragraph 6.2.9 (access to rear components)
- 2) Identify the position of the Air gap in the back of the unit (fig. 1).
- 3) Unscrew the metal bands from the rubber hoses (fig.2 A\_B\_C) (fig.3)
- 4) Cut the plastic bundles of the rubber hoses (fig. 4).
- 5) Remove upper air gap tubes (fig.5)
- 6) Remove the rubber hose that connects to the boiler (fig.6)
- 7) Unscrew the nut that fixes the Air Gap to the backrest of the equipment (fig.7)
- 8) Remove the steel cover that is inside the cavity of the equipment (fig.8)
- 9) Unscrew the plastic containment nut, which fixes the Ari Gap to the inside of the equipment.(fig.9)
- 10) Remove the Air gap from the backrest, and remove the two rubber tubes that are positioned at the bottom of the Air gap.(Fig.10)
- 11) Now the Air gap, can be replaced, **⚠ WARNING**, to reposition or replace the retaining gasket ! (Fig.11)
- 12) Reinstall all components using the reversing procedure and use a suitable tightening torque.

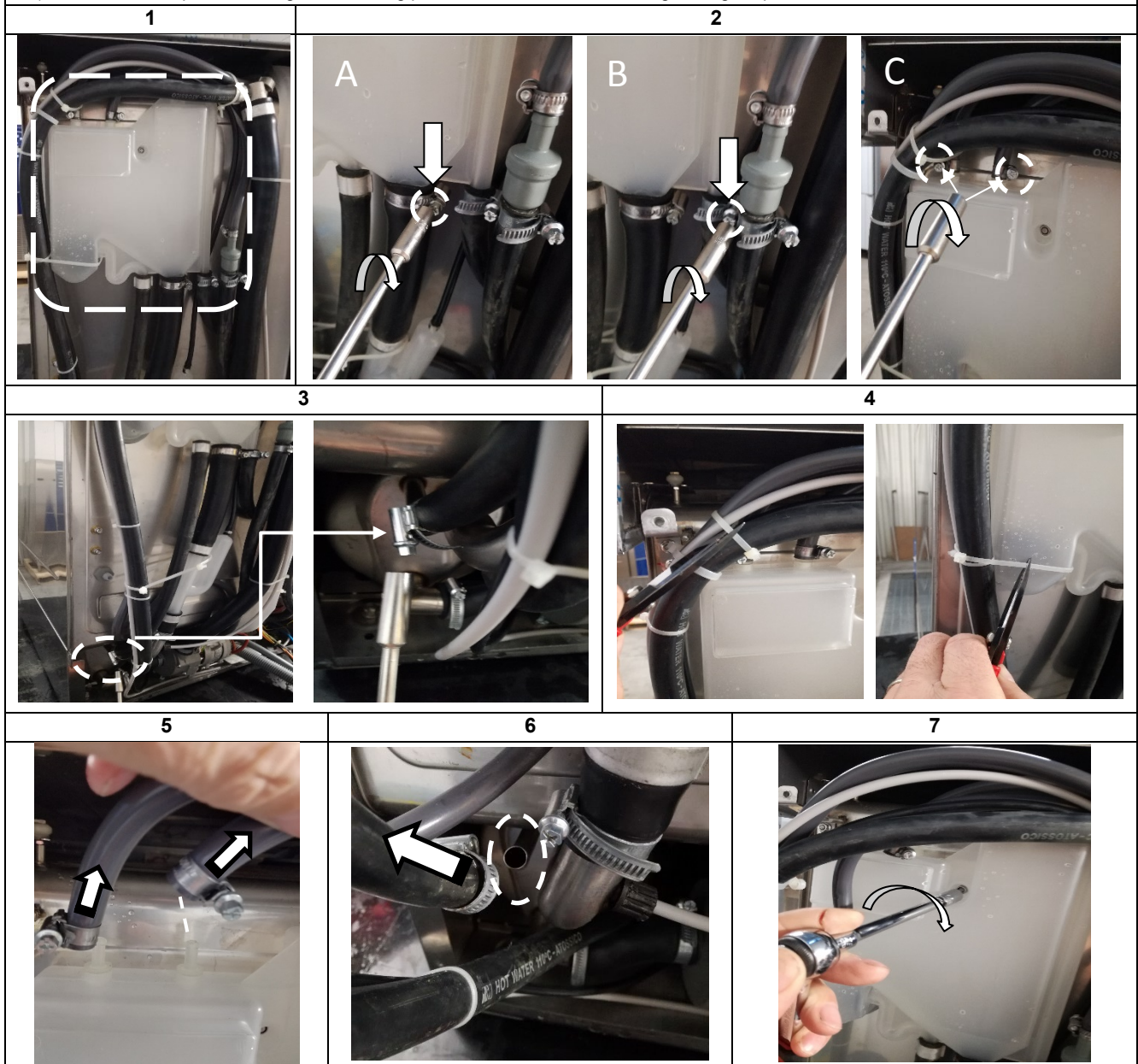

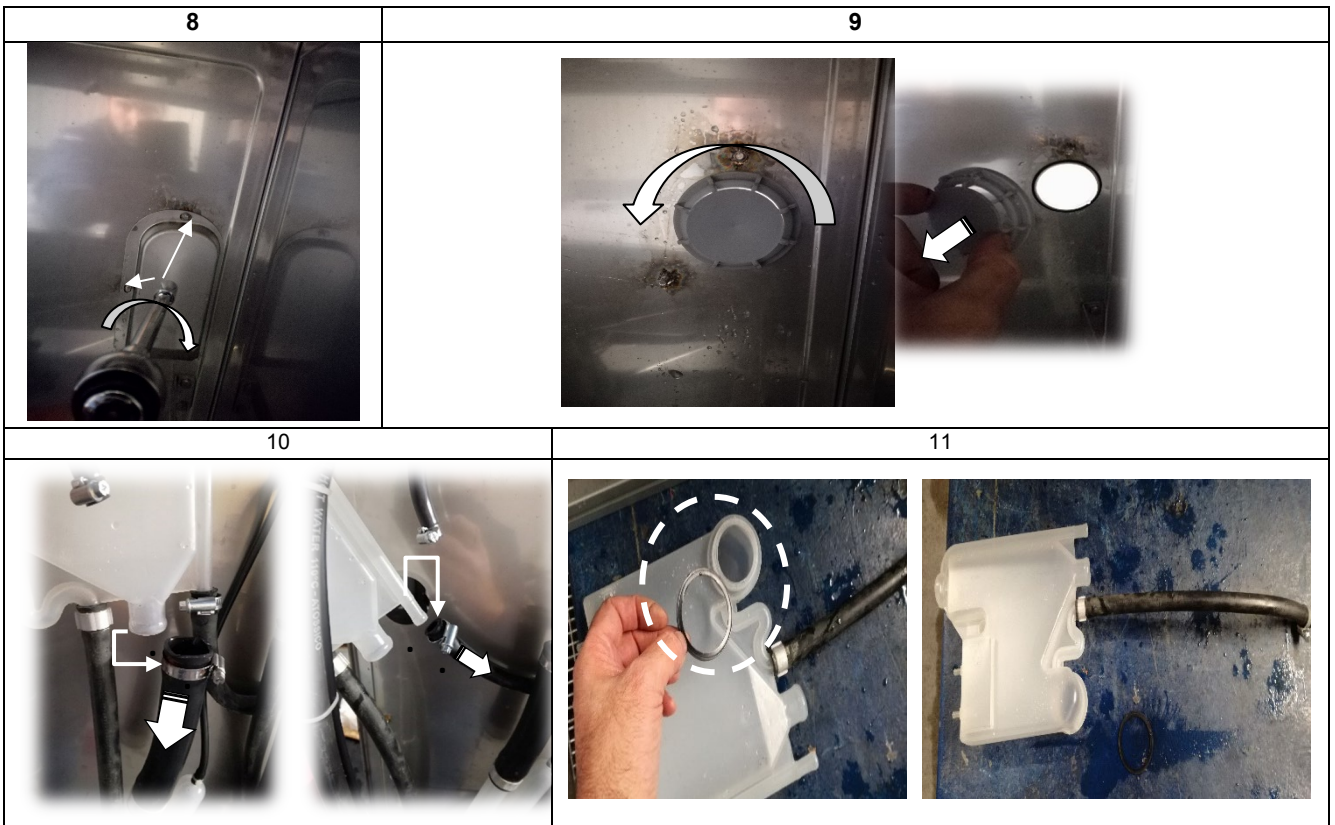

**6.2.19 Water softener B16 replacement**

- 1) Follow the instructions in paragraph 6.2.9 (access to rear components)
- 2) Identify the position of the Water softener in the back of the unit (fig. 1).
- 3) Unscrew the metal bands from the rubber hoses (fig.2 A\_B)
- 4) Remove the rubber hose that connects to upper and lower part (fig.3)
- 5) Loosen the fixing nut of the upper bracket (Fig.4)
- 6) Raise the containment bracket until the "Water softer" is removed.(Fig.5 (1-2-3))
- 7) Reinstall all components using the reversing procedure and use a suitable tightening torque.

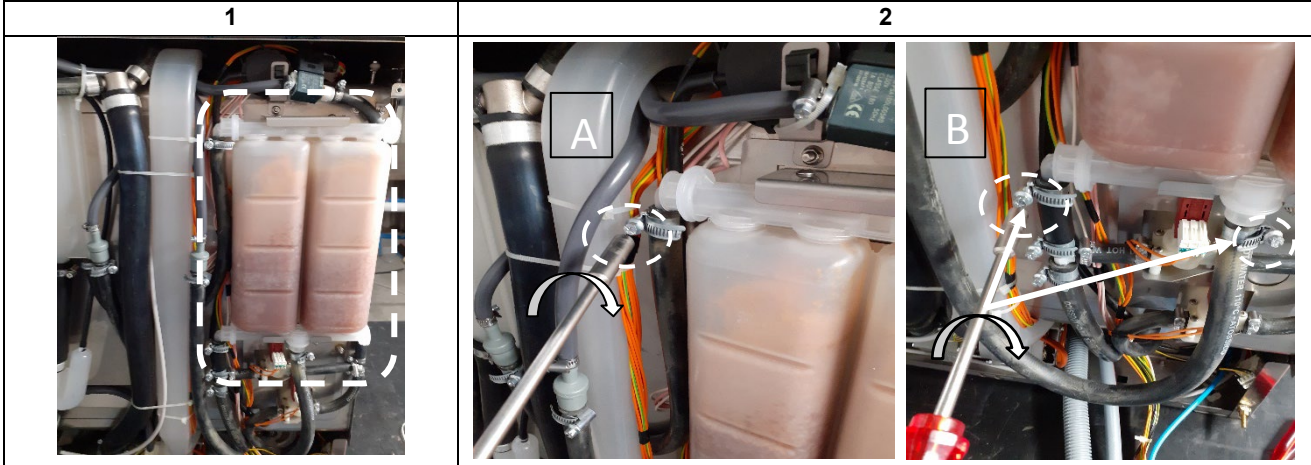



### 6.2.20 Rinse aid pump B17 replacement

- 1) Follow the instruction paragraph 6.2.3 (access to front components)
- 2) Identify the position of the component as shown in figure 1
- 3) Open the fixing cover of the PCB (Fig.1)
- 4) Unscrew the two screws that secure the Pump Rinse Aid (Fig.2)
- 5) Unscrew from Pum Rins aid the tubes connecting to the rinse aid, white and blue color (Fig.3)
- 6) Togliere il conettore di alimentazione dal Pump rinse Aid (fig.4)
- 7) During the reassembly phase, pay attention to the correct installation of the tubes, in the pump slide, is indicated the correct rotation of the pump (fig.5) and consequently the correct installation of the IN and OUT tubes.
- 8) Reinstall all components using the reversing procedure and use a suitable tightening torque.



## 6.2.21 Pressure switch B18 replacement

- 1) Follow the instructions in paragraph 6.2.9 (access to rear components)
- 2) Identify the position of the component as shown in figure 1
- 3) Access the front of the equipment, and unscrew the two side screws Right and Left that secure the control panel.(Fig 2)
- 4) Move the dashboard towards you (Fig.3)
- 5) Remove the pressure switch from its support by pressing it with pliers in its rear hook (Fig.4)
- 6) Remove the rubber hose from the pressure switch (Fig.5)
- 7) Remove the power supply connector from the pressure switch (Fig.6)
- 8) Reinstall all components using the reversing procedure and use a suitable tightening torque

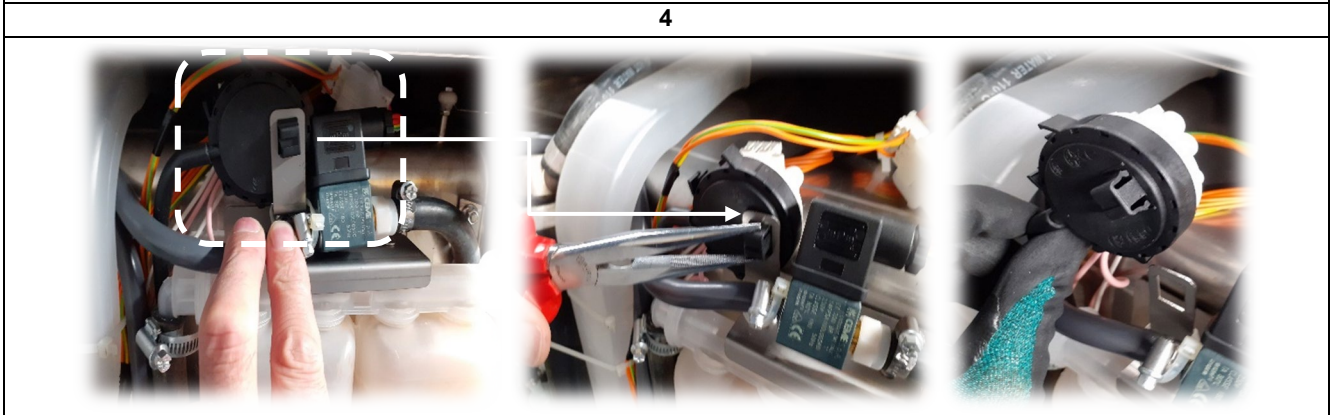
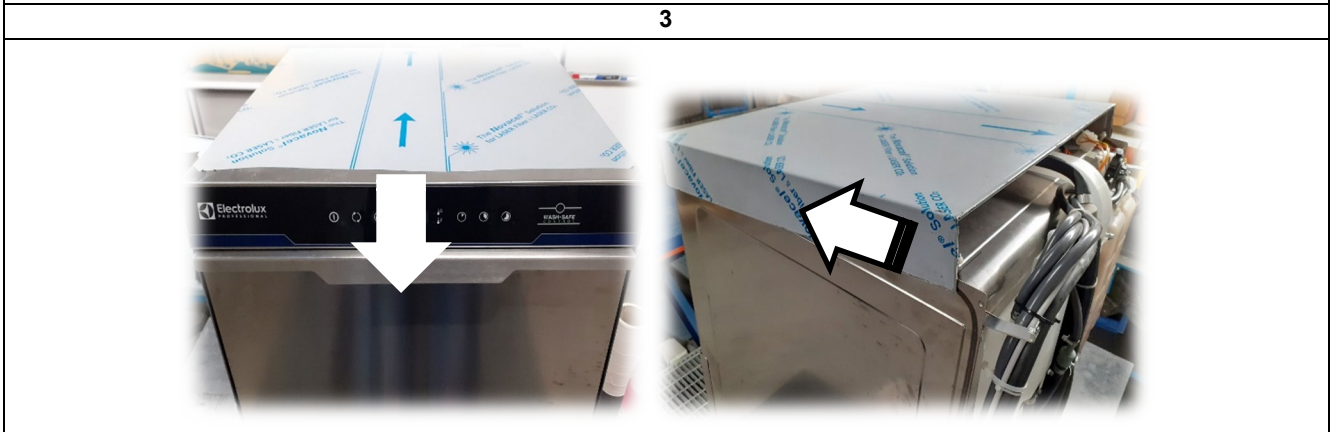
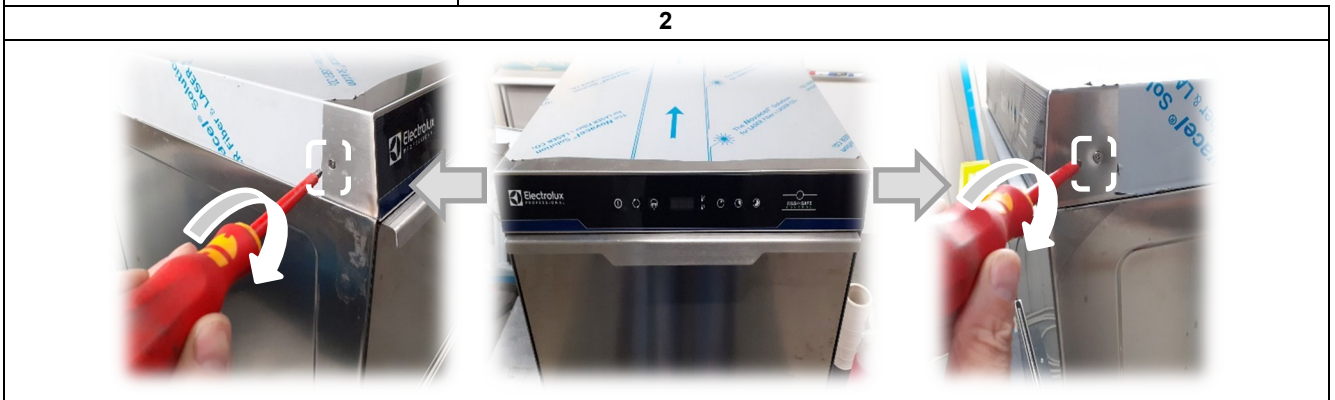
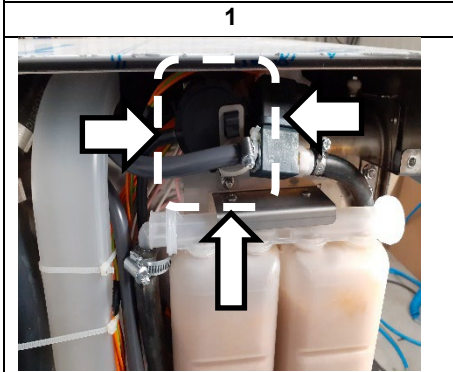



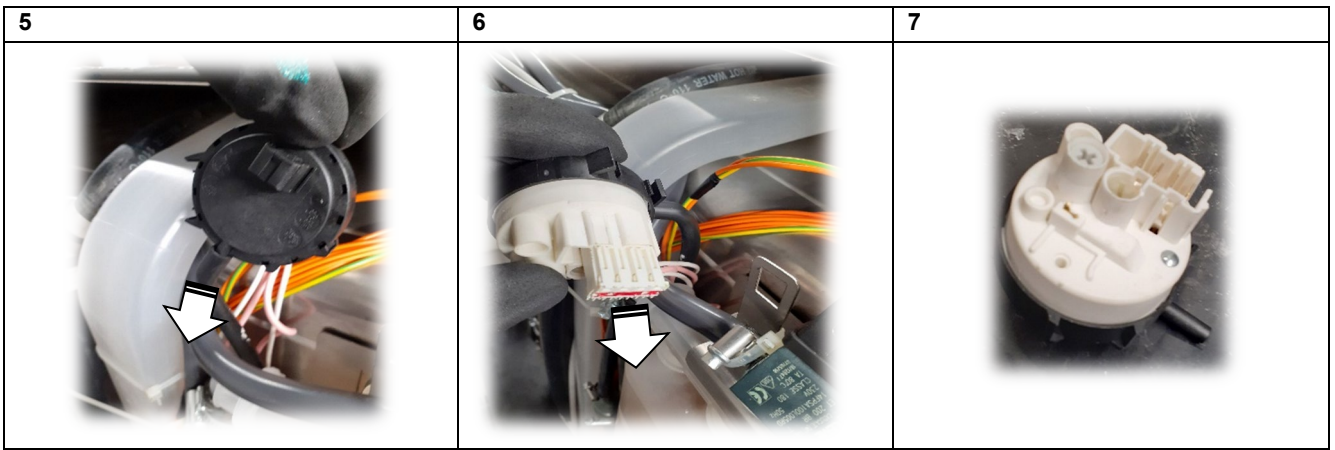

## 6.2.22 User interface B19 replacement

- 1) Access the front of the equipment, and unscrew the two side screws Right and Left that secure the control panel.(Fig 2)
  - 2) Move the dashboard towards you (Fig.2)
  - 3) Raise the control panel and detach the door sensor connector.(Fig.3)
  - 4) Rotate the control panel 180°.(Fig.4)
  - 5) Disconnect the power connector of the user interface (Fig.5)
  - 6) Unscrew the nuts that secure the user interface to the dashboard (Fig.6)
  - 7) Remove the user interface from its housing, also paying attention to the ground cable (Fig.7)
  - 8) Reinstall all components using the reversing procedure and use a suitable tightening torque
- Set up the proper configuration parameters of the appliance according to the model/PNC.  
Please, refer to the Program list and Configuration parameters manual available on website <https://www.electroluxprofessional.com> and <https://webgate.electroluxprofessional.com>.

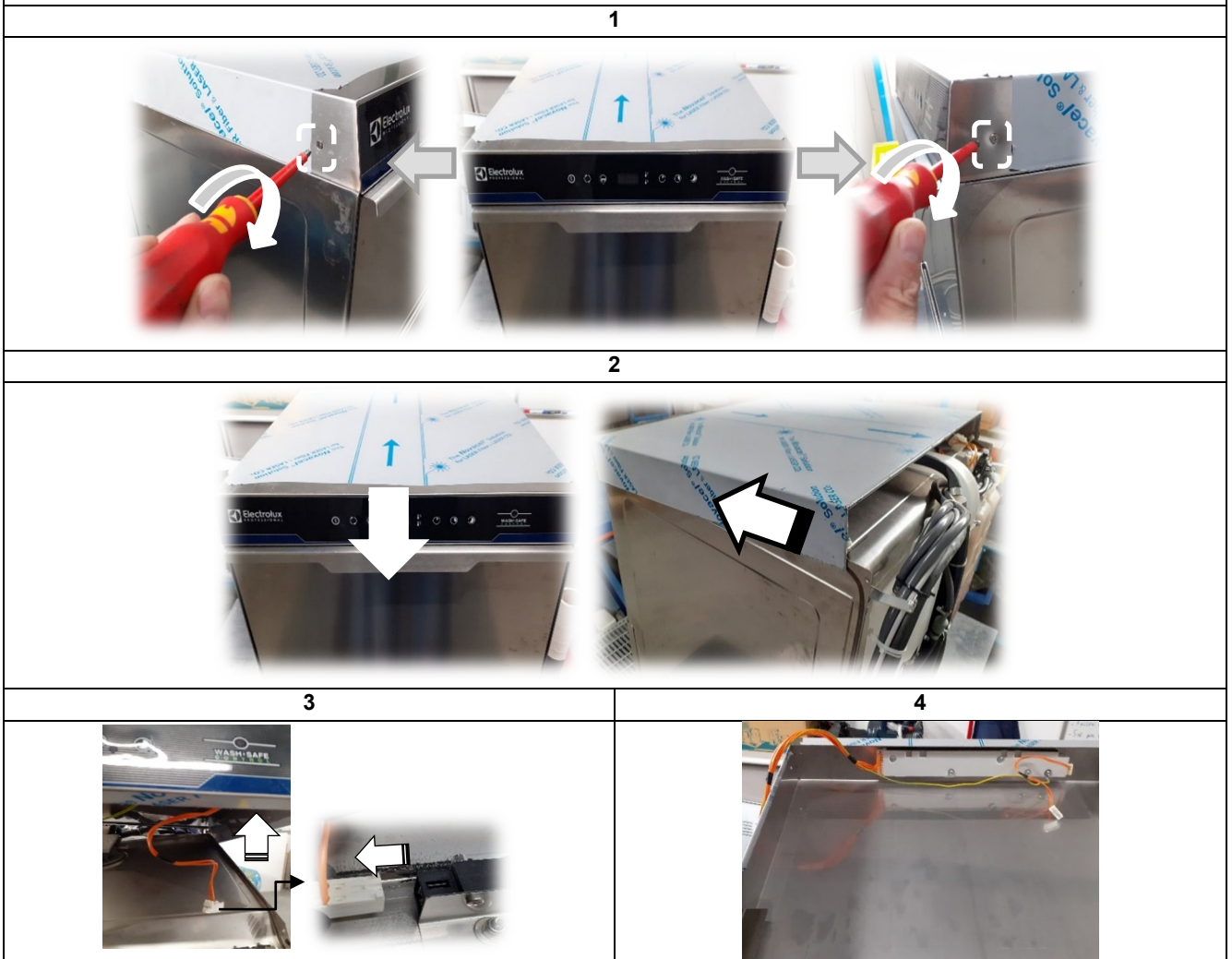

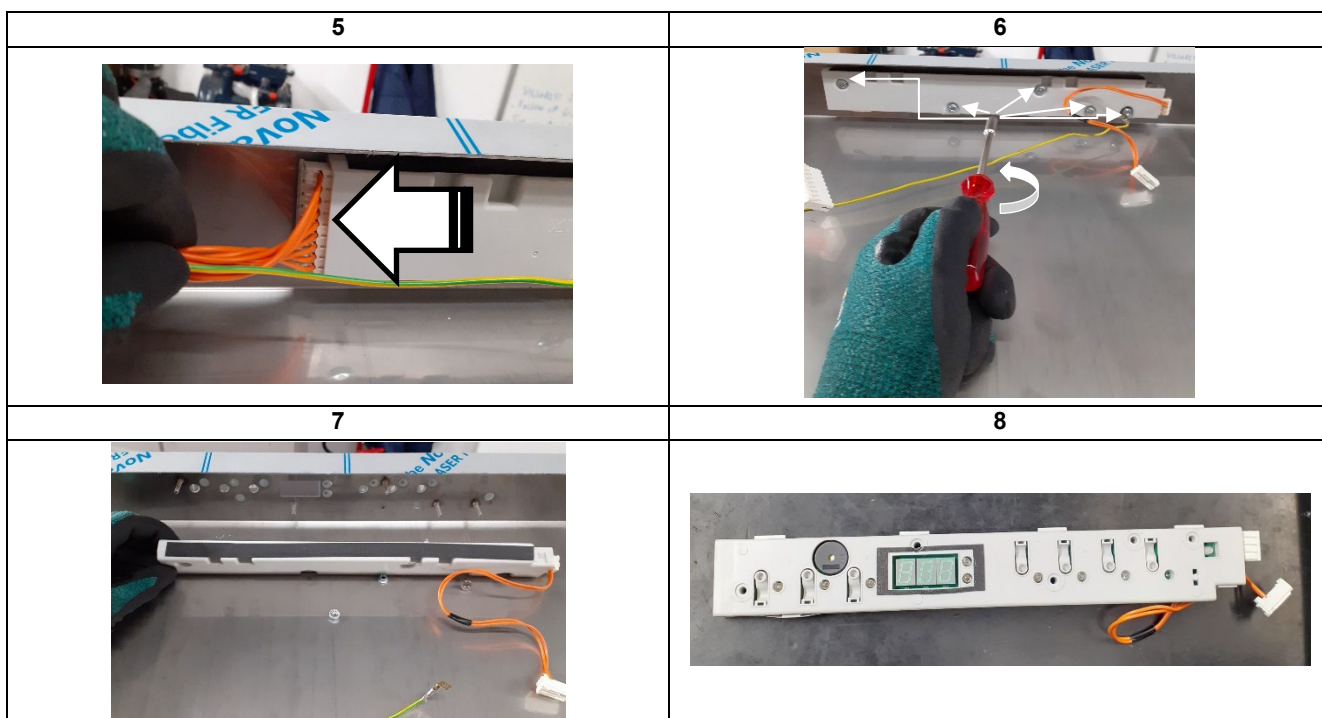

## 6.2.23 Door micro switch B20 replacement

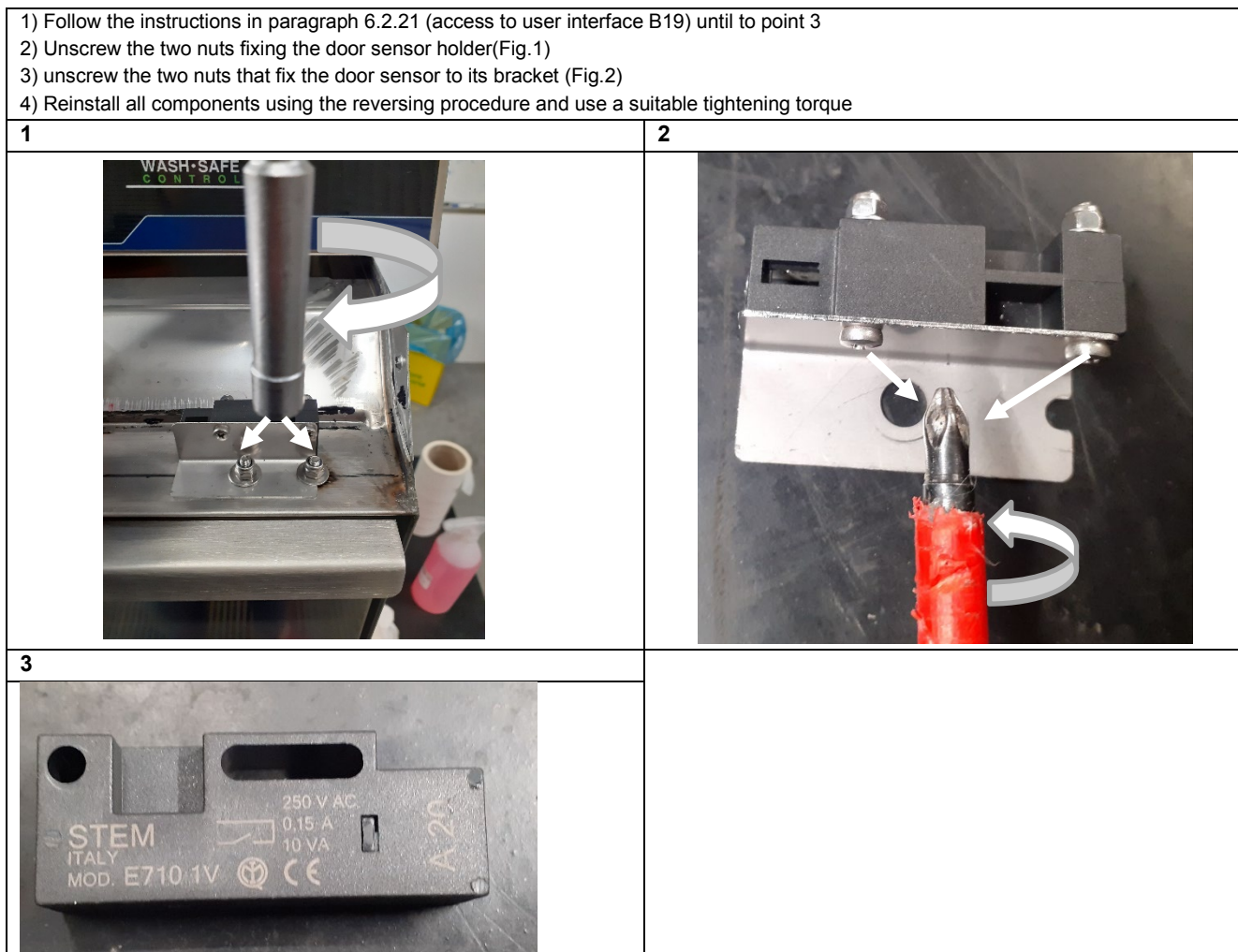

## 6.3 COMPONENTS REPLACEMENT - DOUBLE SKIN UNDERCOUNTER

This chapter explains how to remove various parts of the equipment to access its functional components: please always refer to this guide to access various parts.



**DANGER!** Before any operation on the machine read chapter 1.2 SAFETY INFORMATION/PRECAUTIONS.



**DANGER!** Before doing any work on the equipment ALWAYS unplug it from the power supply (danger of fatal electric shock!).

To reinstall a part, follow the instructions in reverse order to those described below.

### 6.3.1 Components layout double skin undercounter

Pos.	Component
C1	Door
C2	Mainboard
C3	Salt container
C4	Boiler heating element
C5	Boiler temperature sensor
C6	Tank heating element
C7	Boiler
C8	Tank temperature sensor
C9	Clixson tank heating element
C10	Wash pump
C11	Drain manifold tank
C12	Rinse pump
C13	Loading solenoid valve
C14	Drain pump
C15	Detergent pump
C16	Continuous water softener
C17	Rinse aid dispenser
C18	Tank pressure switch
C19	User interface
C20	Door micro switch

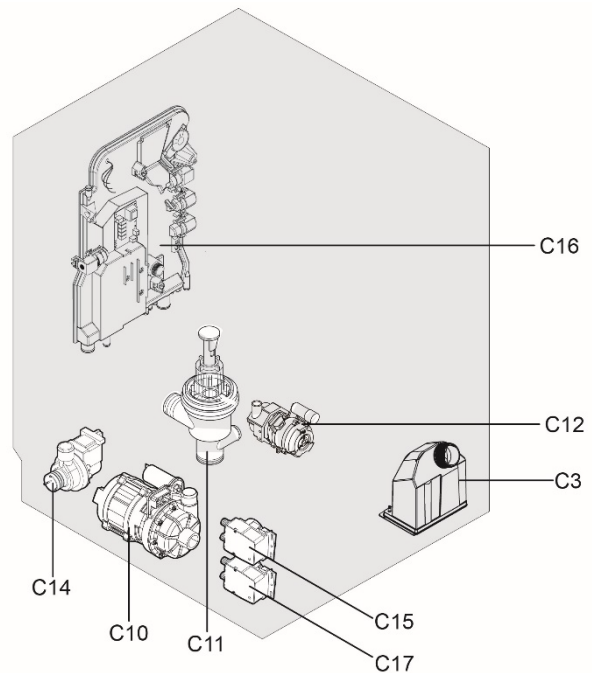
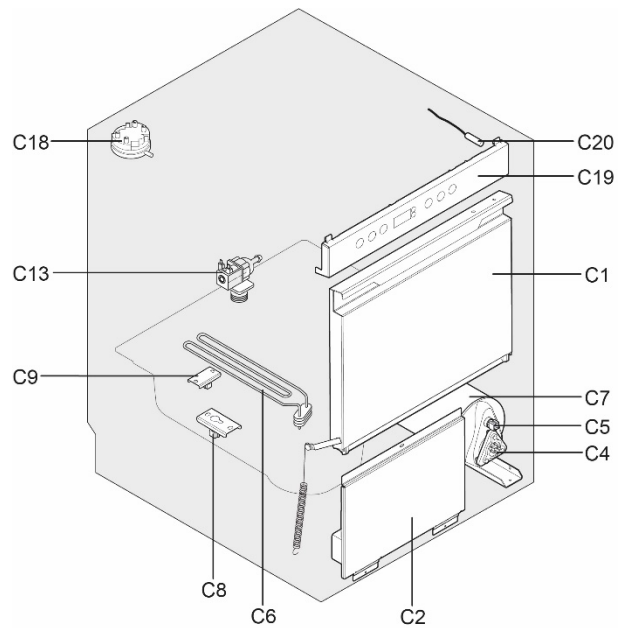

## 6.3.2 Door C1 replacement

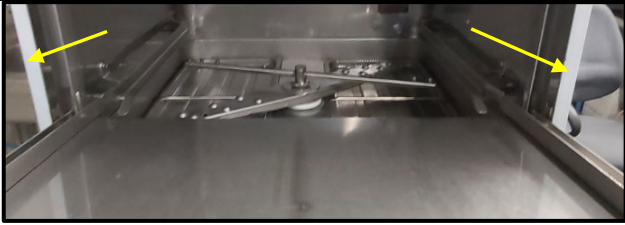
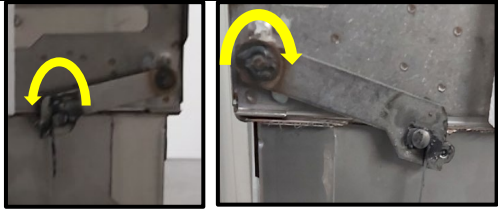
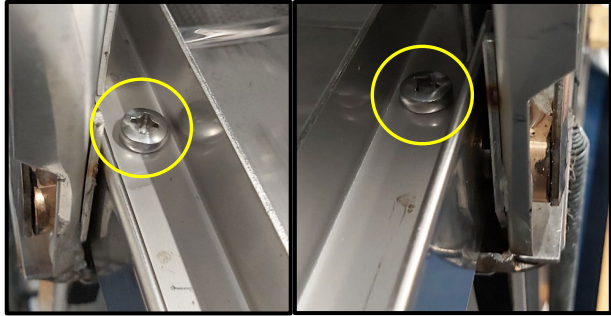
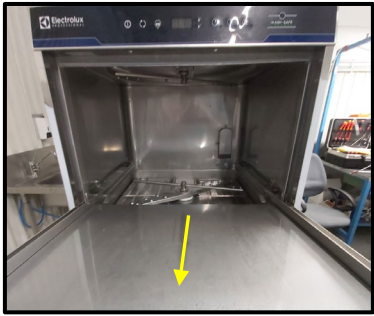
<ol style="list-style-type: none"> <li>1) Open the door and remove left and right panel.</li> <li>2) Remove the spring left and right of arms support (Fig.1)</li> <li>3) Unscrews the left and right hinges bolts (Fig.2)</li> <li>4) Pull out the door</li> <li>5) The components, as pins, hinges and seger they are all removed (Fig.2 and 3)</li> <li>6) Reinstall all components using the revers procedure ,and use a tightening torque appropriate.</li> </ol>	
1	2
	
3	4
	

## 6.3.3 Access to front components

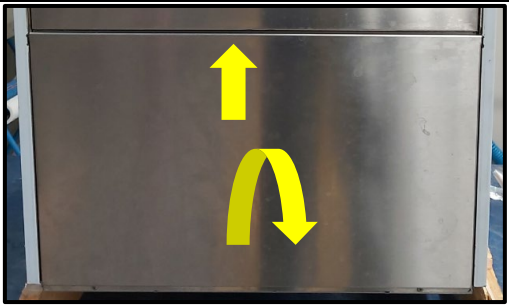
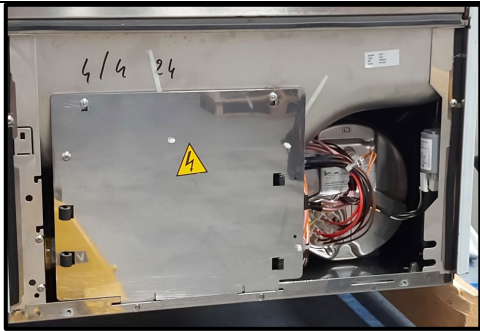
<ol style="list-style-type: none"> <li>1) Remove the front screw on the bottom (Fig.1)</li> <li>2) Lift up and down on the front panel to take it away (Fig.2)</li> <li>3) The View of the open part, the front component will be access (Fig.3)</li> <li>4) Reinstall all components using the revers procedure ,and use a tightening torque appropriate</li> </ol>	
1	2
	
3	
	

## 6.3.4 Main board C2 replacement

- 1) Following the instruction paragraph 6.3.3 (access to front components)
- 2) Remove two bolt of the support main board (Fig.1)
- 3) Pull down the support main board (Fig.1 and 2)
- 4) Remove the connectors of main board (Fig.3)
- 5) Press the two pins in the left position of main board and pull up all main board (Fig.4)
- 6) Reinstall all components using the revers procedure, and use a tightening torque appropriate

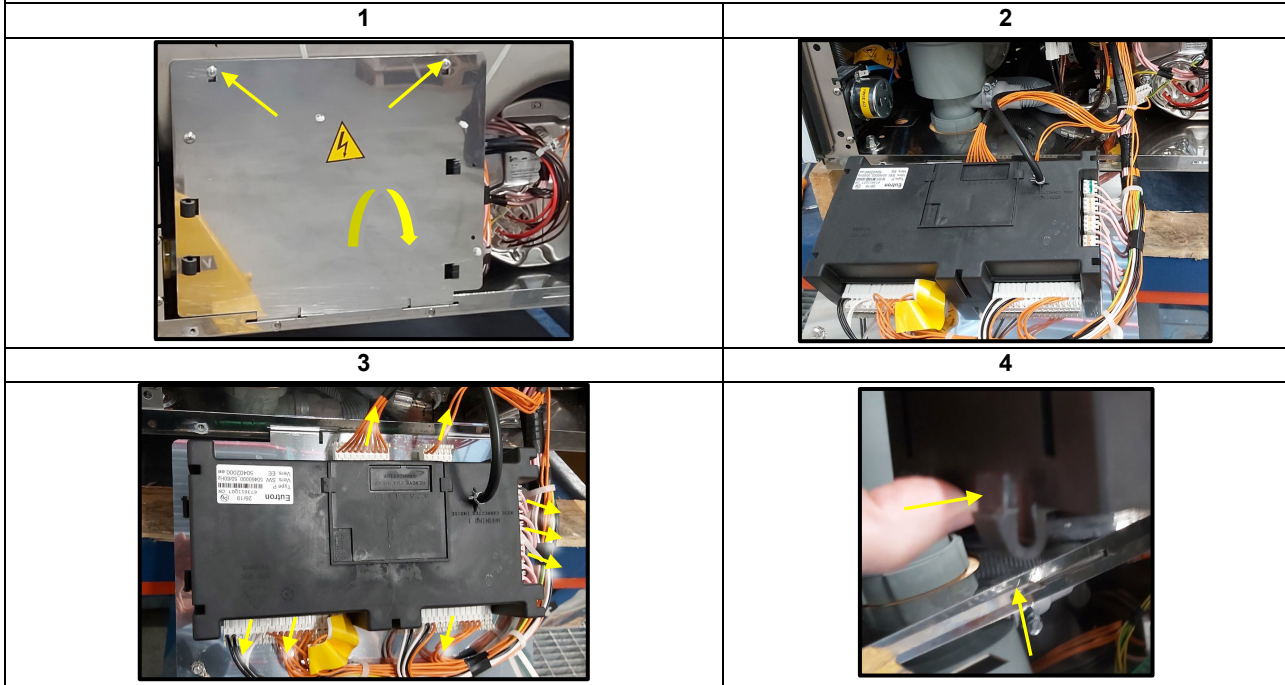

## 6.3.5 Water softener C16 and salt container C3 replacement

- 1) Following the instruction paragraph 6.3.3 (access to front components)
- 2) Remove the bolt of the salt container (Fig.1), and remove hose and electrical connection (Fig.2)
- 3) Remove all the panel around.
- 4) Remove all the hose from the water softener (Fig.3)
- 5) Remove all the electrical connection (Fig.4), to remove the electronic board and cable (Fig.4) particular A, first remove away the water softener.
- 6) Reinstall all components using the revers procedure, and use a tightening torque appropriate

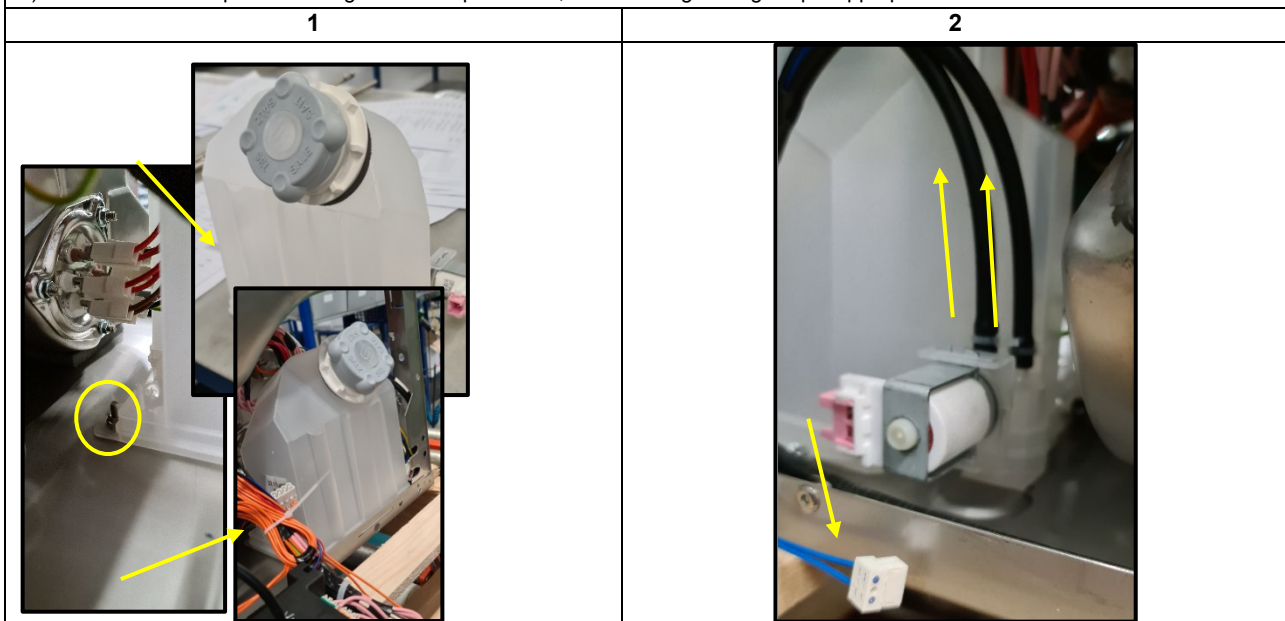

3

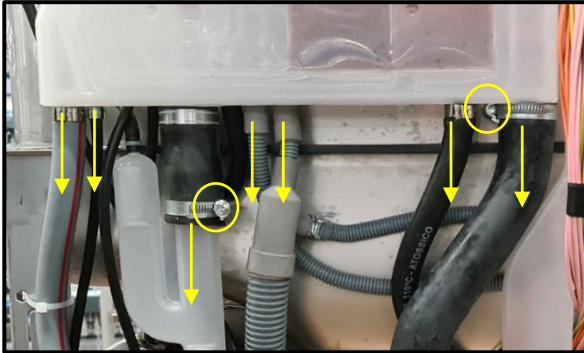

4

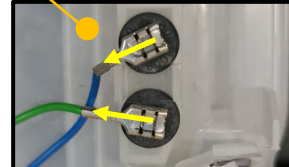
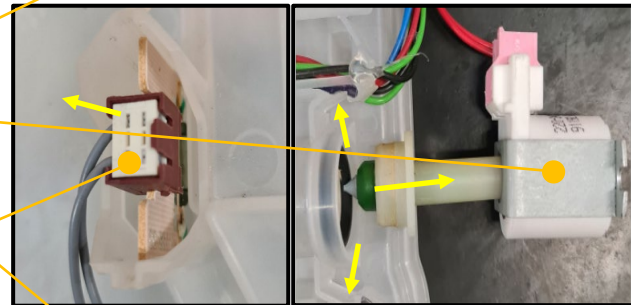
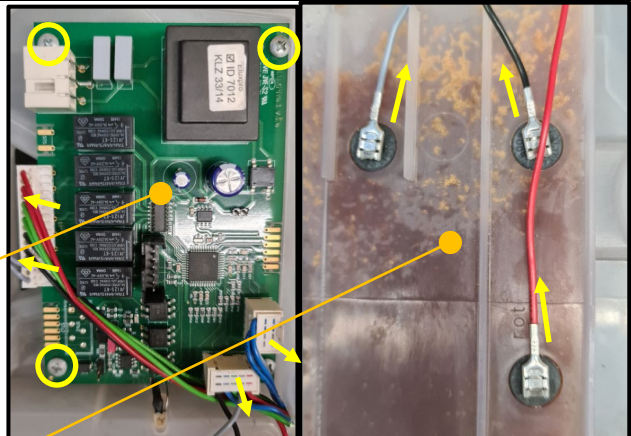
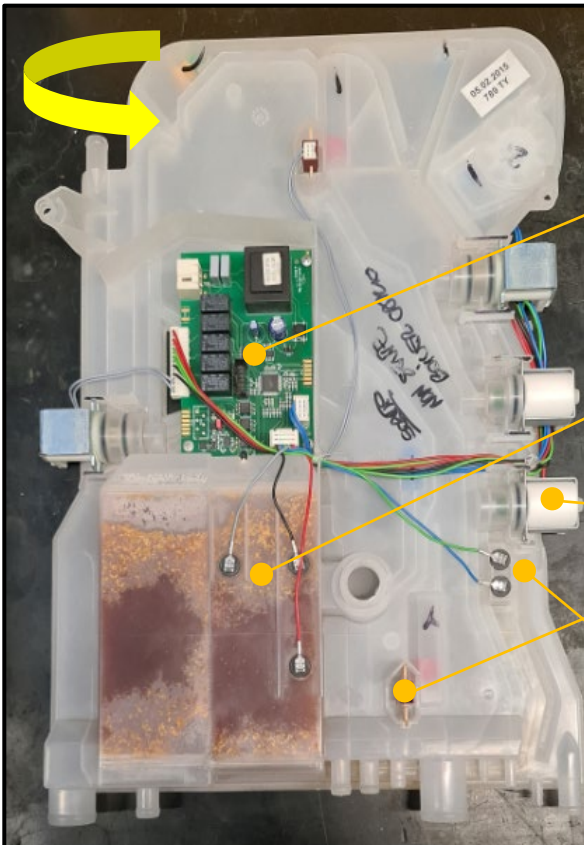
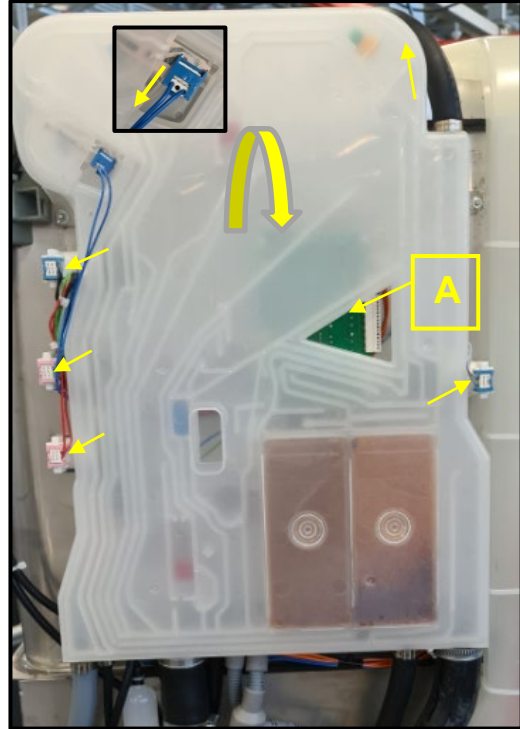

## 6.3.6 Boiler heating element C4 replacement

- 1) Following the instruction paragraph 6.3.3 (access to front components)
- 2) Remove the wiring connector present in the boiler heating element (Fig.2)
- 3) Remove the three bolts that fix the boiler heating element (Fig.3)



**Attention! Water may be present inside the boiler! The presence of water can damage other nearby components in case of direct contact**

- 4) Pull Out the boiler heating element
- 5) Attention in case of replacement, that the Oring is present in the heating element (Fig.4)
- 6) Reinstall all components using the revers procedure ,and use a tightening torque appropriate

1

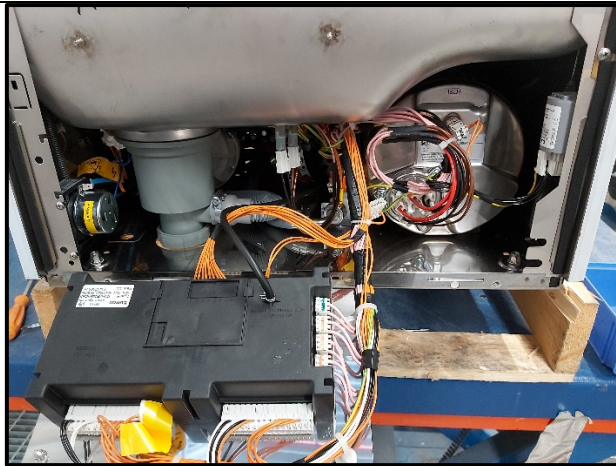

2

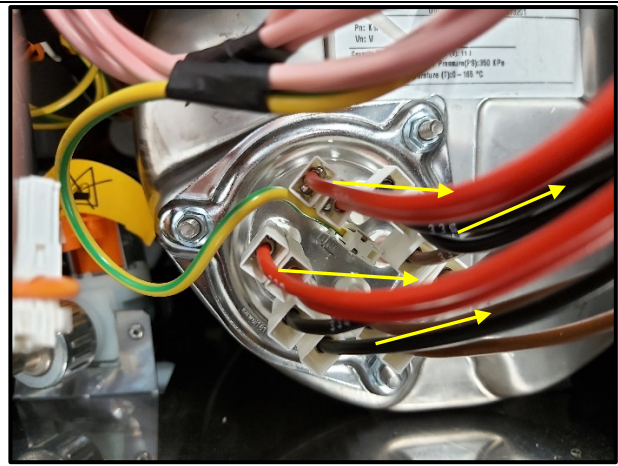

3

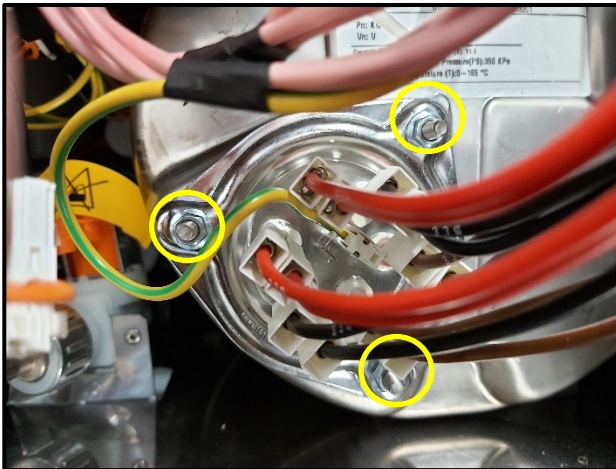

4





## 6.3.7 Boiler temperature sensor C5 replacement

- 1) Following the instruction paragraph 6.3.3 (access to front components)
- 2) Remove the wiring connector present in the boiler temperature sensor (Fig.1)
- 3) Unscrew the boiler temperature sensor using an appropriate tools (Fig.2)

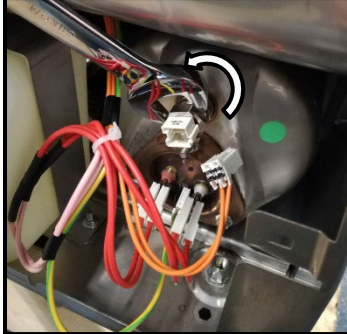

**Attention! Water may be present inside the boiler! The presence of water can damage other nearby components in case of direct contact**

- 4) Pull Out the boiler temperature sensor from to boiler (Fig.3)
- 5) Attention in case of replacement, replace also the Oring in the boiler temperature sensor (Fig.4)
- 6) Reinstall all components using the revers procedure ,and use a tightening torque appropriate

1	2	3
		
		

## 6.3.8 Tank heating element C6 replacement

- 1) Following the instruction paragraph 6.3.3 (access to front components)
- 2) Open the door and remove the basket inside (Fig.1)
- 3) Remove the wiring connector in the tank heating element (Fig.2)
- 4) Remove the nut that fix the GRD wiring (Fig.3)
- 5) Remove the rubber protection present in the tank heating element (Fig.4)
- 6) Remove the nut and bottom stopper that fix the tank heating element (Fig.5)
- 7) Remove the stopper inside of cavity that fix the tank heating element (Fig.6)
- 8) Pull out the tank heating element (Fig.7)
- 9) Reinstall all components using the revers procedure, and use a tightening torque appropriate

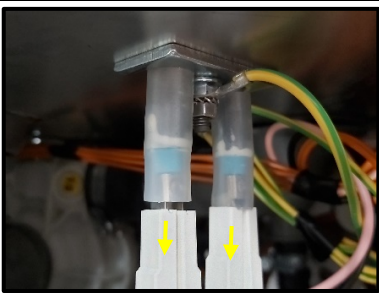
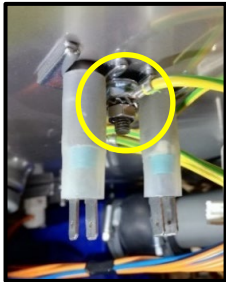
1	2	3
		



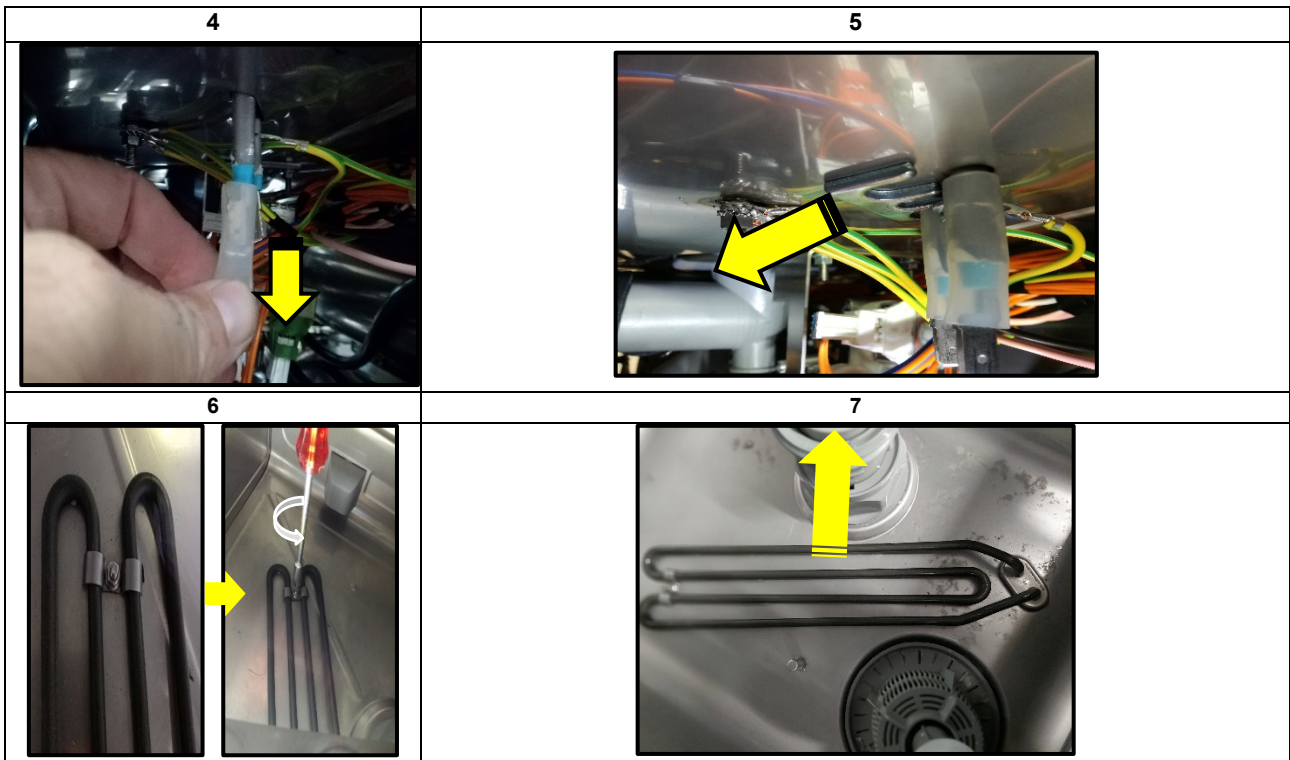

### 6.3.9 Access to back components

- 1) In the back part of the unit remove all connections as: pipes, and electrical power if connected.
- 2) Unscrews 9 screws that fix the back panel (Fig.2)
- 3) Remove the wiring ground cable (Fig.3)
- 4) Open the back panel protections, and disconnect the connector in the clamp (Fig.4)
- 5) Take out the back panel
- 6) Reinstall all components using the revers procedure, and use a tightening torque appropriate

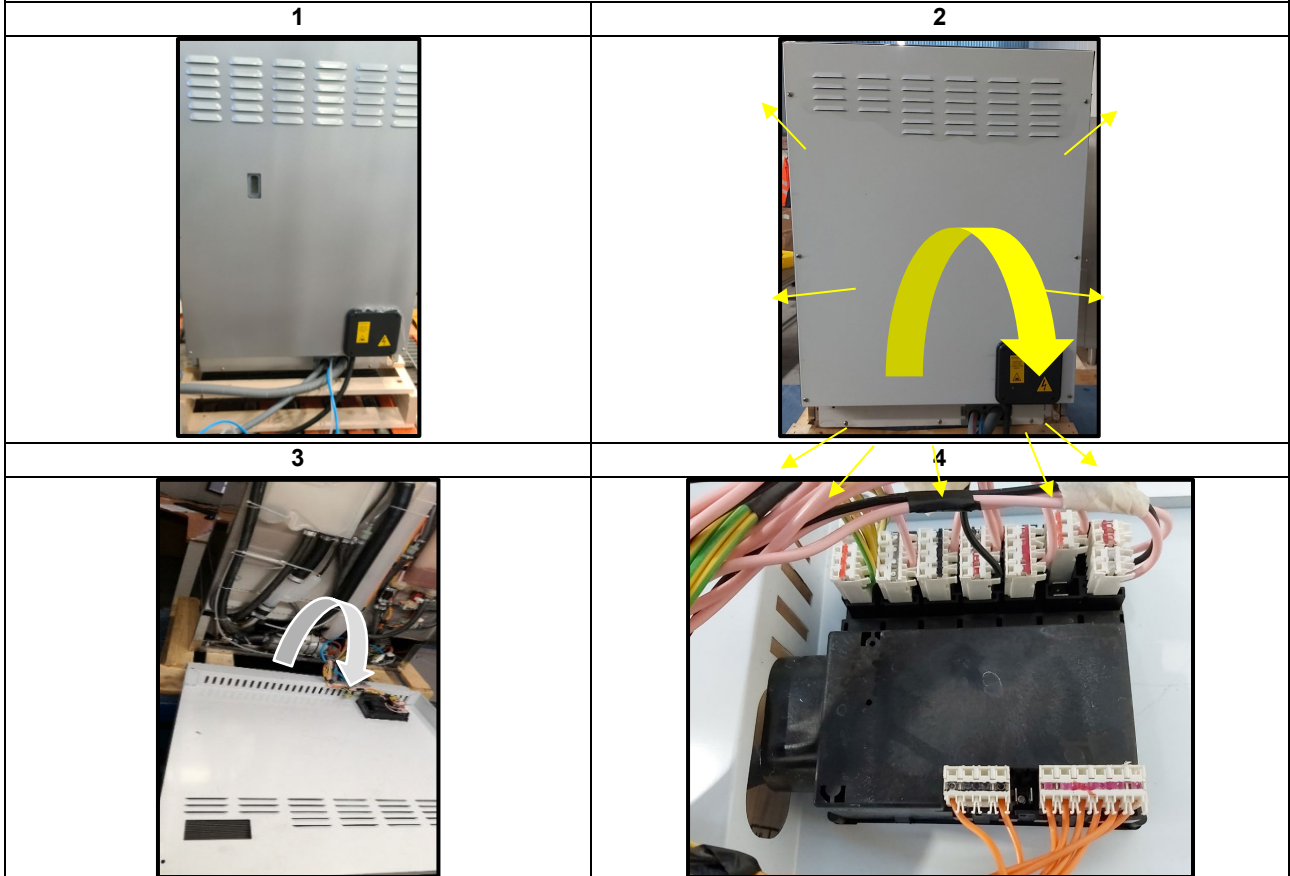

## 6.3.10 Boiler C7 replacement

- 1) Follow the instruction paragraph 6.3.3 (access to front components)
- 2) Remove the wiring connector present in the boiler heating element (Fig.1)
- 3) Following the instruction paragraph 6.3.9 (access to back components)
- 4) Remove the metallic strip that fix the rubber pipe to the Boiler (Fig.2)
- 5) Remove the rubber pipe from the boiler (Fig.2)
- 6) Loose the metal clamp open it and extract the boiler from the side (Fig.3)

**⚠ Attention! Water may be present inside the boiler! The presence of water can damage other nearby components in case of direct contact,**

- 7) Reinstall all components using the revers procedure, and use a tightening torque appropriate

1

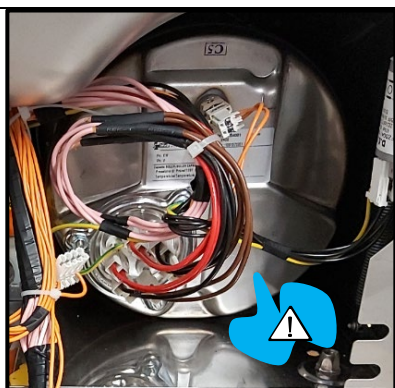

2

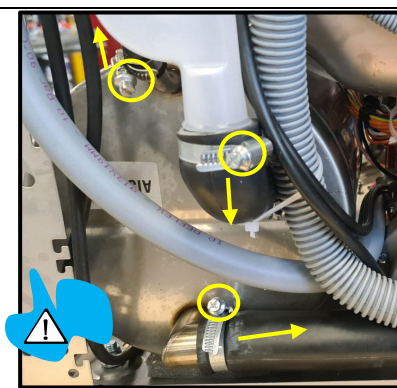

3

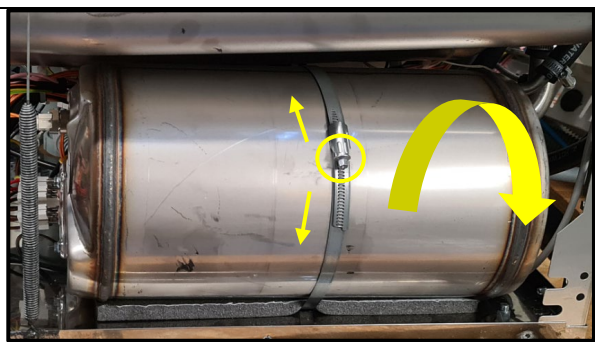

## 6.3.11 Tank temperature sensor C8 replacement

- 8) Overtun left or inclination unit till to access to the bottom panel
  - 1) Unscrews the left side panel
  - 2) Identification the position of tank sensor in the bottom part of the unit (Fig.1)
  - 3) Disconnect the wiring cable (Fig.2)
  - 4) Remove two nut that fix the tank sensor plate (Fig.3)
  - 5) Pull out the sensor (Fig.4)
  - 6) Every change need a new gasket (Fig.5)
- ⚠ Attention** in case of replacement, that the Oring is present in the heating element (Fig.4)
- 7) Reinstall all components using the revers procedure, and use a tightening torque appropriate

1

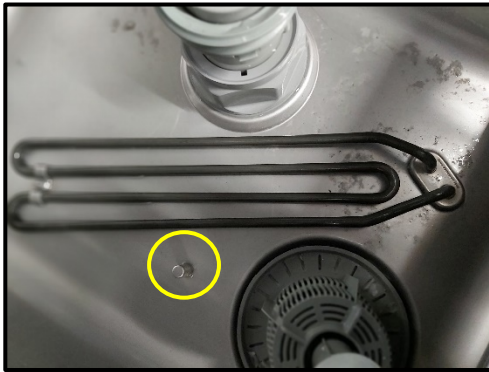

2

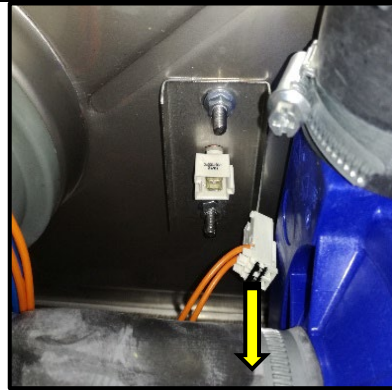

3



4







5

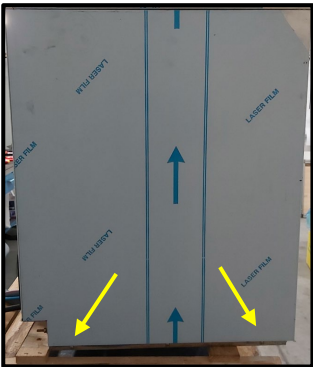
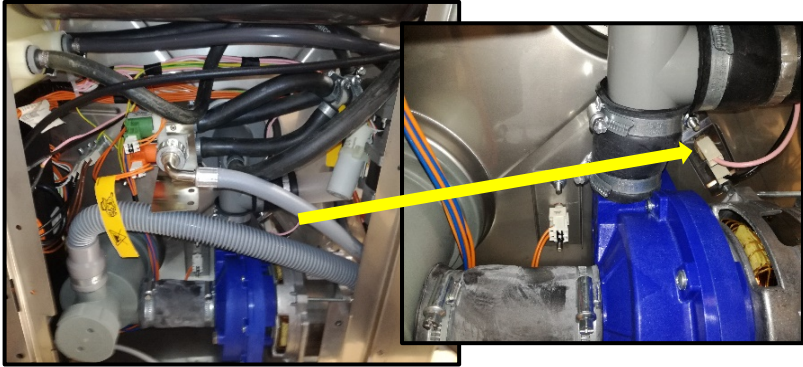
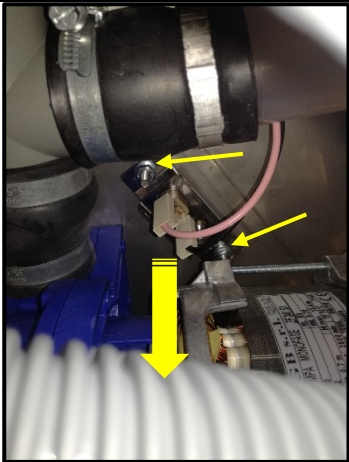

## 6.3.12 Clixson tank heating element C9

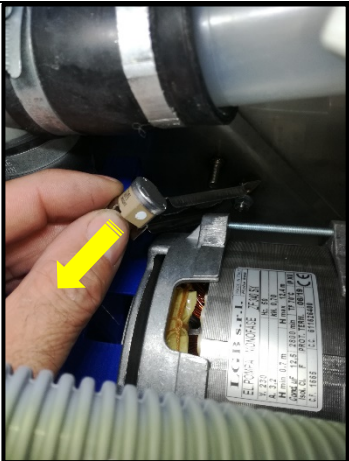
- 1) Follow the instruction paragraph 6.3.9 (access to back components)
- 2) Unscrew all panel, front access, back side, left and right side.
- 3) Unscrews two screws of the left panel and from the front, and pull towards the right (Fig.1)
- 4) Identification the position of the clixson in the bottom part of the unit (Fig.2)
- 5) Disconnect the wiring cable (Fig.3)
- 6) Remove the nuts that fix the tank sensor plate (Fig.3)
- 7) Unscrew the second nut that fix the tank sensor plate , without remove completely (Fig.3)
- 8) Turn tu right the plate support and remove the sensor (Fig.4)
- 9) Pull out the clixson (Fig.5)
- 10) Reinstall all components using the revers procedure, and use a tightening torque appropriate

<p><b>1</b></p> 	<p><b>2</b></p> 
<p><b>3</b></p> 	<p><b>4</b></p> 
<p><b>5</b></p> 	<p><b>6</b></p> 

## 6.3.13 Wash pump C10 replacement

- 1) Follow the instructions in paragraph 6.3.9 (access to rear components)
- 2) Open all panel panel (Fig.1).
- 3) Unscrew two screws of the bottom panel and pull to the right (Fig.1).
- 4) Identify the position of the washing pump at the bottom of the unit (Fig.2).
- 5) Unscrew the fixing clamps that fix the rubber fittings (horizontal and vertical) in the washing pump (Fig.2 and 3).
- 6) Move the clamp towards the center of the rubber fitting (Fig.2 and 3).
- 7) Disconnect the feed connector of the wash pump (Fig.4)
- 8) Remove the screws that secure the pump bracket support on the bottom (Fig.5).
- 9) Remove two screws securing the pump wash bracket.
- 10) Remove the wash pump bracket.
- 11) Move the wash pump to the right and remove the rubber hose (Fig.2 and 3).
- 12) Turn the wash pump to the left and pull it out.
- 13) Before reinstalling a new pump, it is recommended to use new rubber hose fittings and to facilitate insertion use oil for insertion or unscrewing.
- 14) Reinstall all components using the reversing procedure and use a suitable tightening torque.

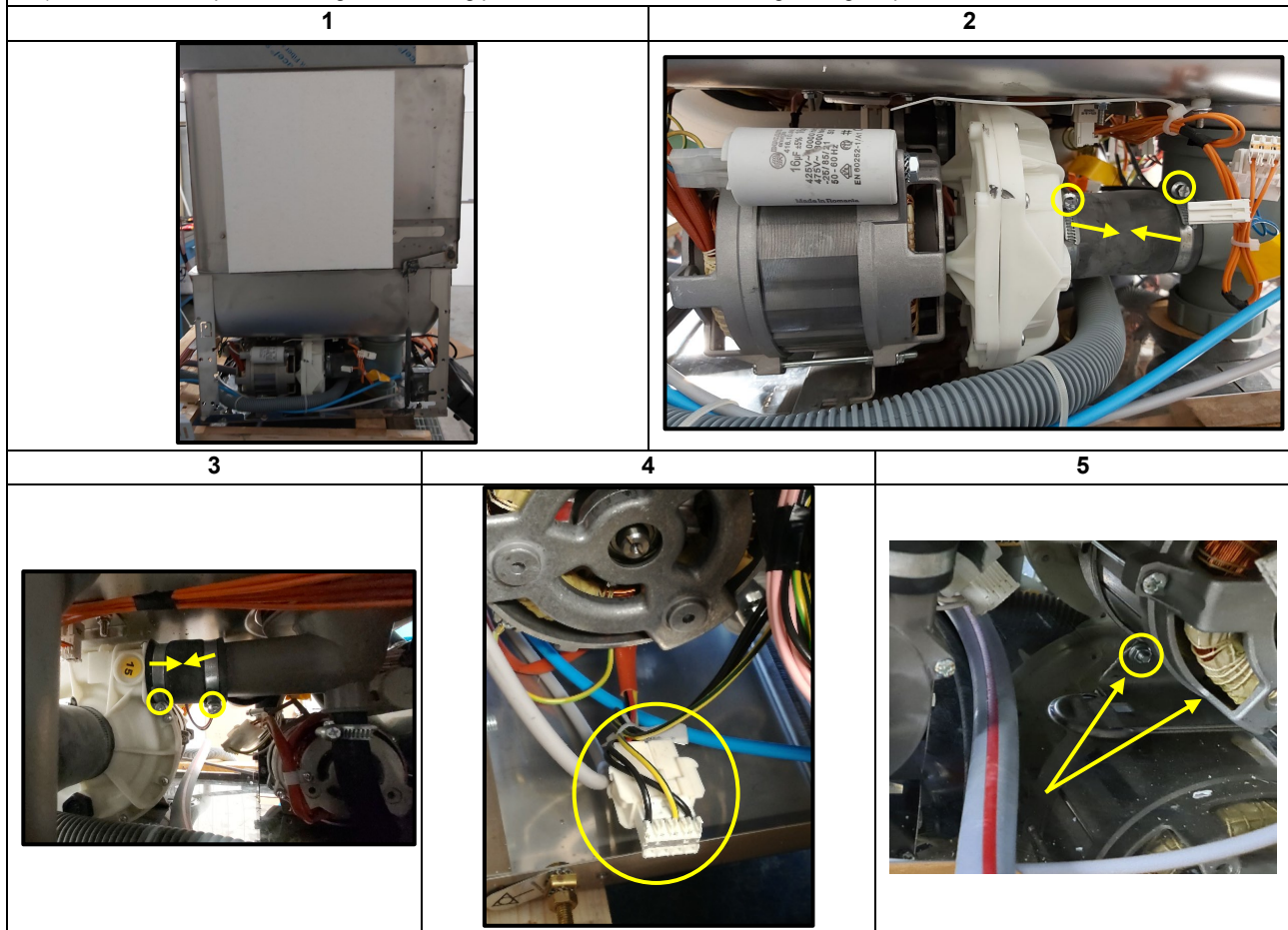

## 6.3.14 Drain manifold tank C11 replacement

- 1) Follow the instructions in paragraph 6.3.9 (access to rear components)
  - 2) Follow the instruction paragraph 6.3.3 (access to front components)
  - 3) Remove the components inside of tank as filters, cover, wash and rinse arms (Fig.2)
  - 4) Tilt or lean the unit to the left until you reach the bottom panel.
  - 5) Unscrew two screws of the bottom panel and pull to the right.
  - 6) Identify the position of the discharge cover filter tank in the bottom of the unit
  - 7) Unscrew the fixing clamps that fix the rubber plumb fittings (horizontal and vertical) in the washing pump and in the discharge cover filter (Fig.3, 4, 5).
  - 8) Remove the screws that secure the pump bracket support on the bottom (Fig.5).
  - 9) Turn to left the cover filter tank, using an appropriate tools, till to remove the plastic nut that fix the filter cover discharge in the wash tank, see A,B, and C (Fig.6)
  - 10) Remove the drain collector from bottom part (Fig.7)
- ⚠ Attention** in case of replacement, that the Oring is present in the heating element (Fig.8)
- 11) Before reinstalling a new pump, it is recommended to use new rubber hose fittings and to facilitate insertion use oil for insertion or unscrewing.
  - 12) Reinstall all components using the reversing procedure and use a suitable tightening torque.

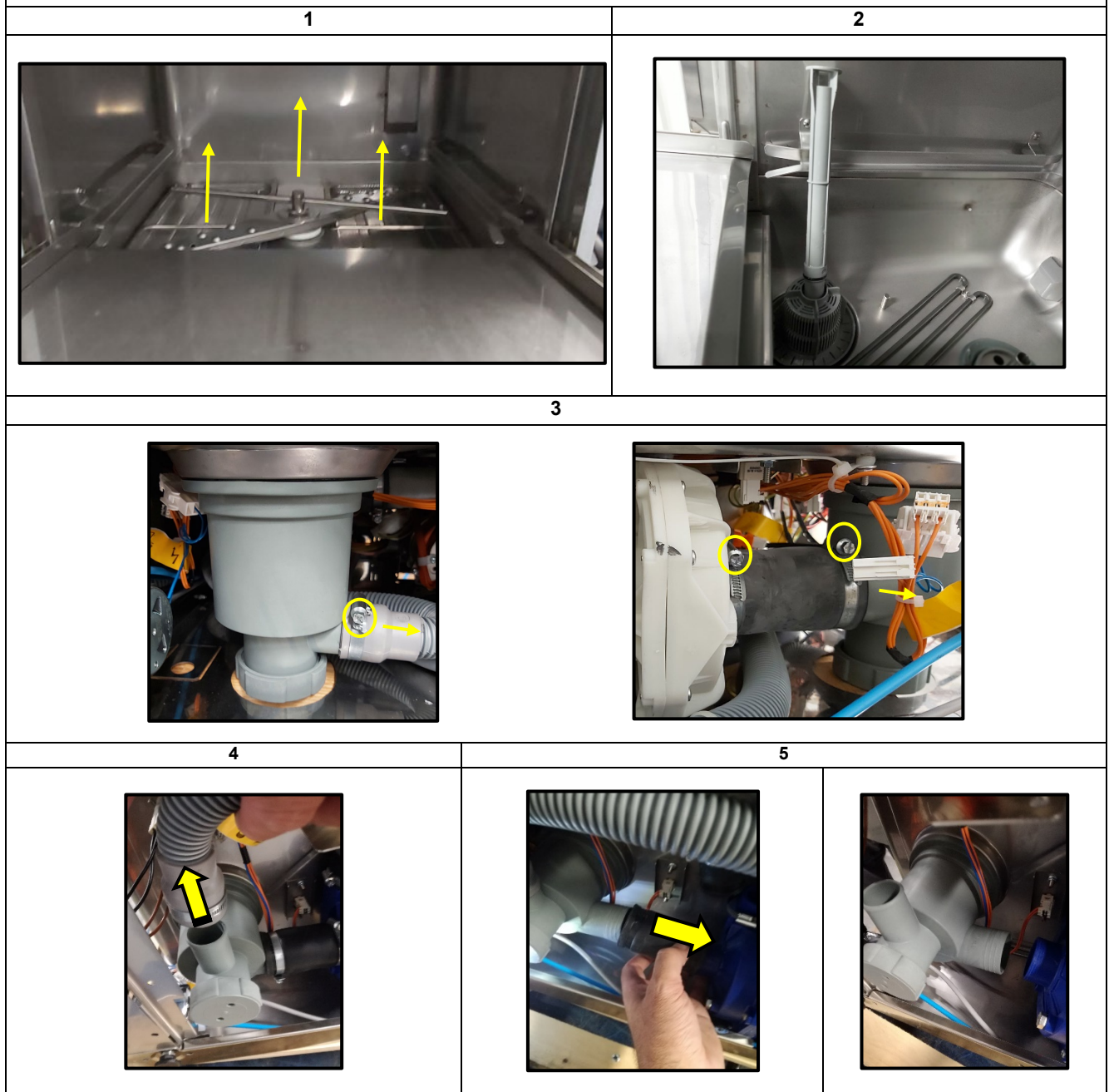

6

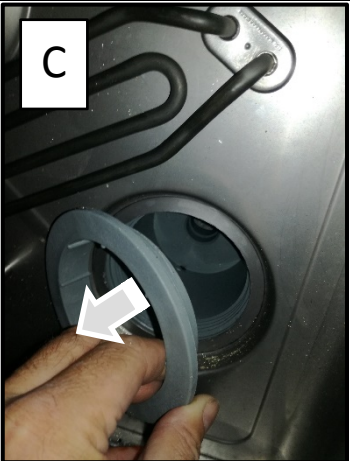
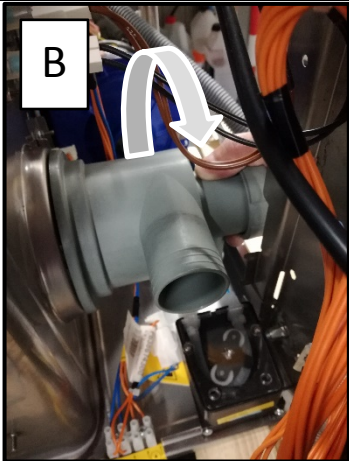
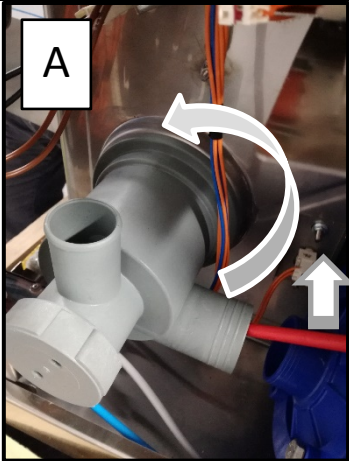

7

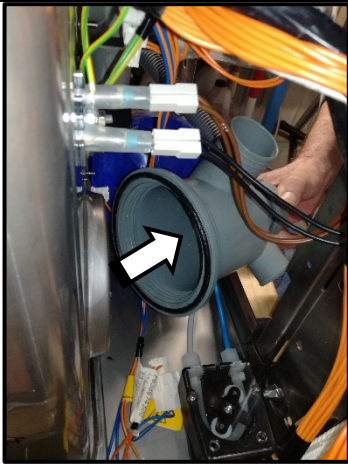

8



## 6.3.15 Rinse pump C12 replacement

- 1) Following the instruction paragraph 6.3.3 (access to front components)
- 2) Remove the clamp, and move away the hose (Fig.1)
- 3) Disconnect the wiring (Fig.2)
- 4) Remove the bolt from below the machine (Fig.3)
- 5) Reinstall all components using the revers procedure

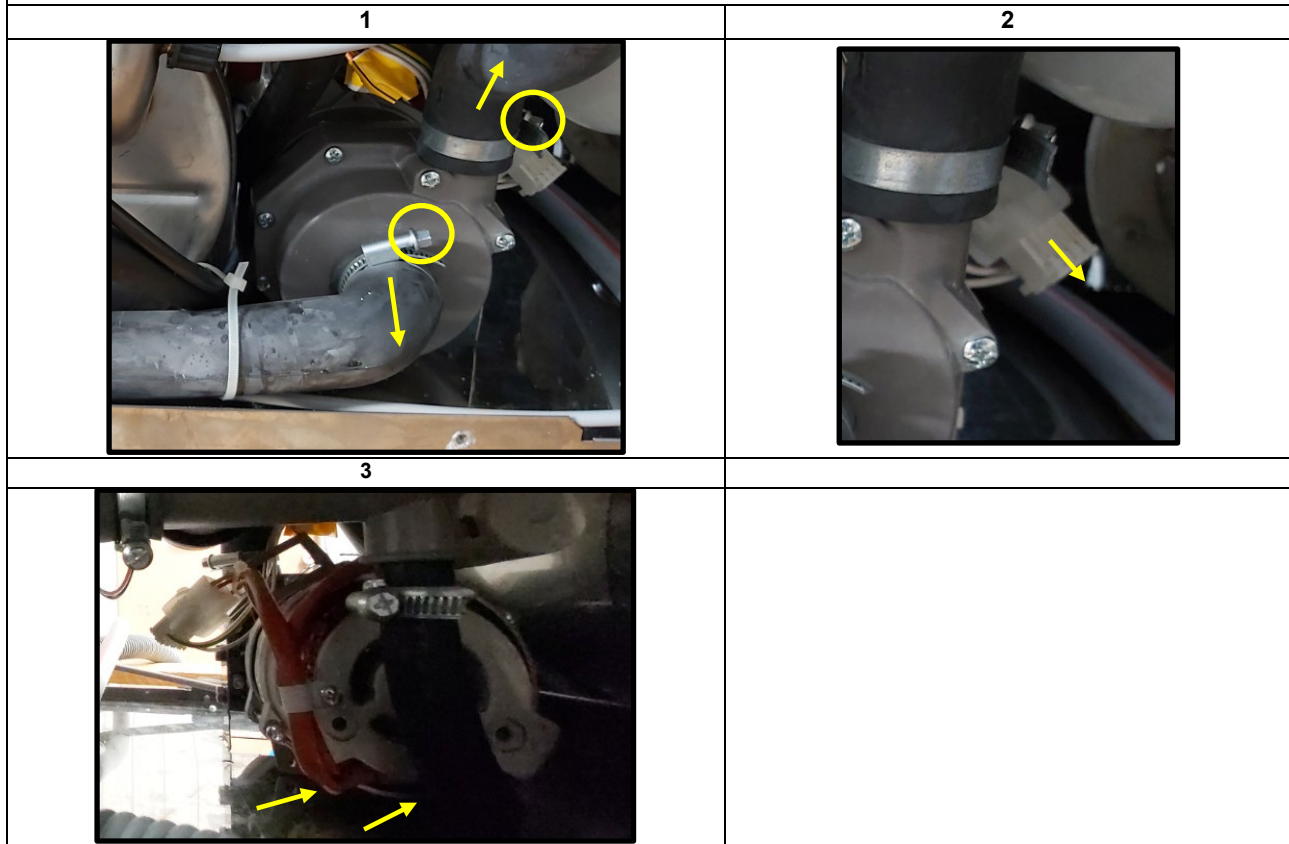

## 6.3.16 Loading solenoid valve C13 replacement

- 1) Following the instruction paragraph 6.2.14 (access to the back components)
- 2) Remove the wiring (Fig.1)
- 3) Remove the incoming water connection hose (Fig.1)
- 4) Loose and remove the water connection hose (Fig.2)
- 5) Loose the screw behind and remove the solenoid valve (Fig.3)
- 6) Reinstall all components using the revers procedure

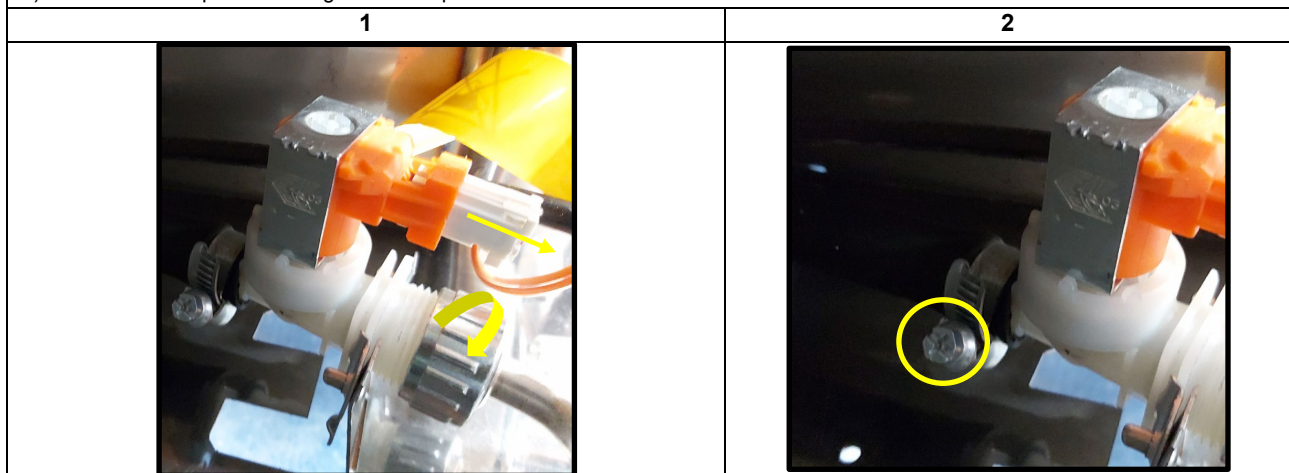



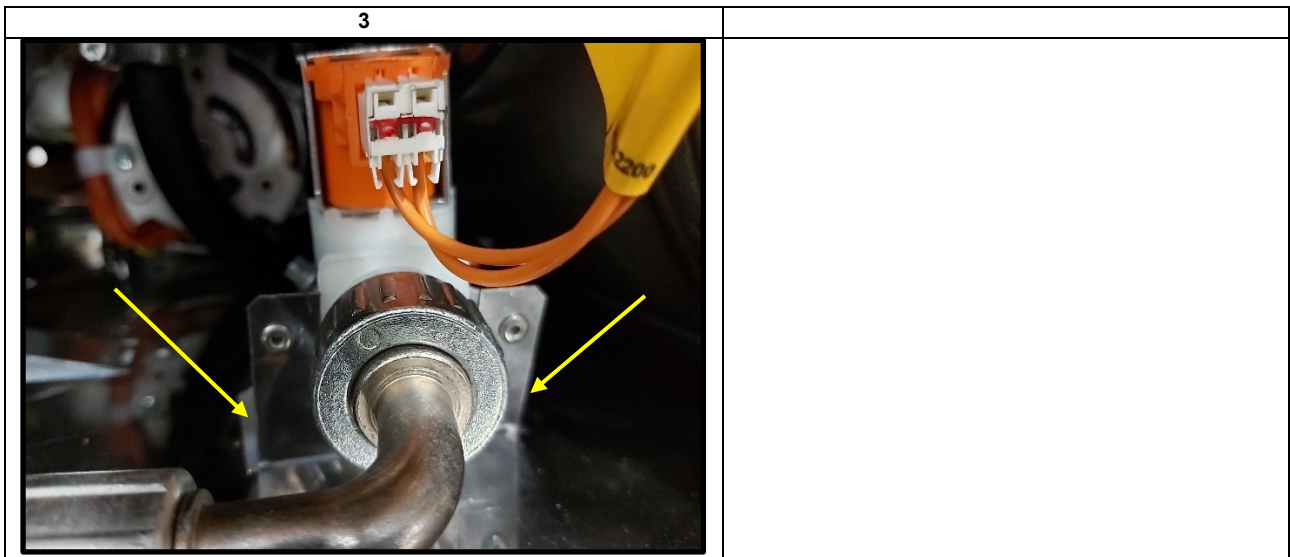

### 6.3.17 Drain pump C14 replacement

- 1) In the back part of the unit remove all connections as: pipes, and lectrical power if connected.
- 2) Unscrews 9 screws that fix the back panel
- 3) Remove the wiring ground cable
- 4) Open the back panel protections (Fig.1), and disconnect the connector in the clamp (Fig.2) and screw (Fig.3)
- 5) Take out the back panel
- 6) Reinstall all components using the revers procedure, and use a tightening torque appropriate

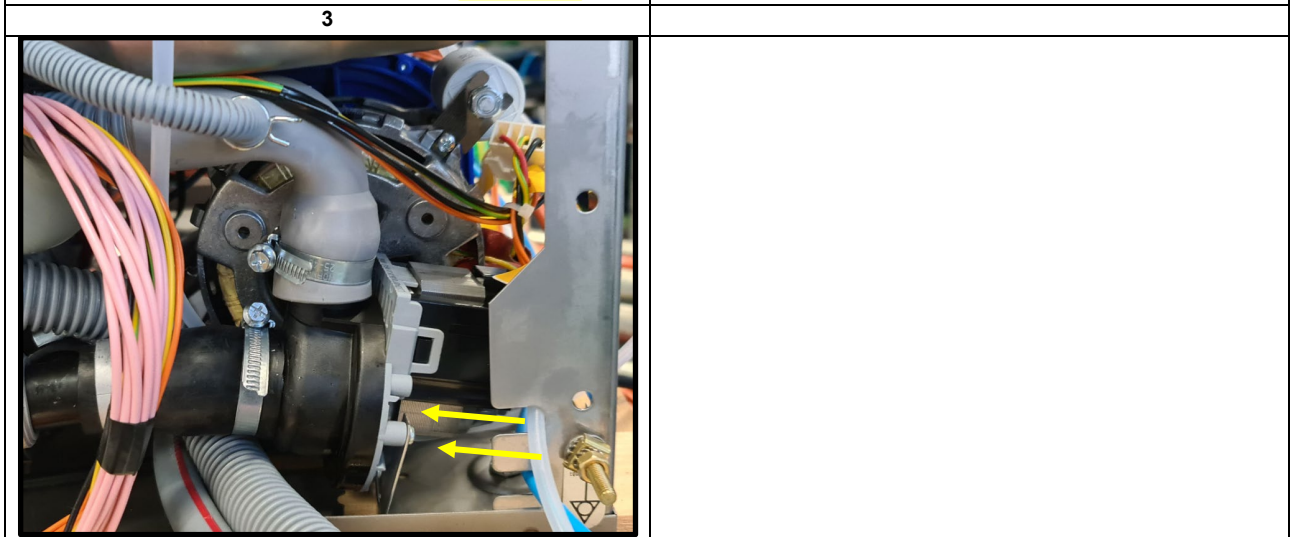
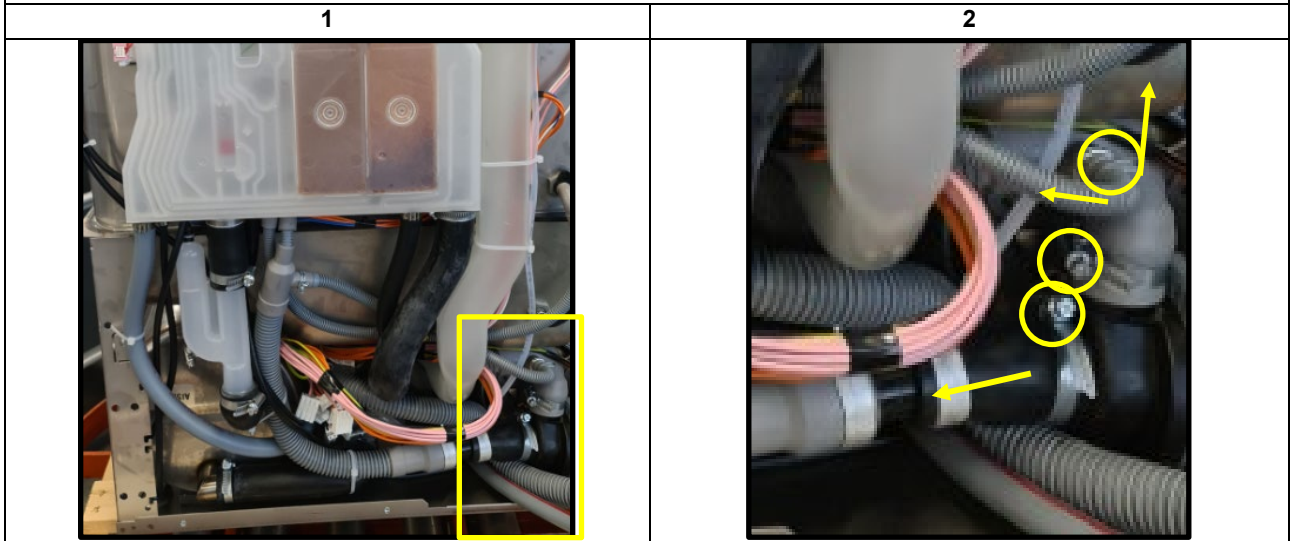

## 6.3.18 Detergent pump C15 and rinse aid pump C 17 replacement

- 1) Following the instruction paragraph 6.3.3 (access to front components)
- 2) Remove two bolt of the support main board (Fig.1 and Fig.3) pull out on the front the pump
- 3) Pull down the support main board (Fig.1 and 2)
- 4) Remove the pipe connection in the back (Fig.1). follow and disconnect the wiring (Fig.2)
- 5) Reinstall all components using the revers procedure, and use a tightening torque appropriate

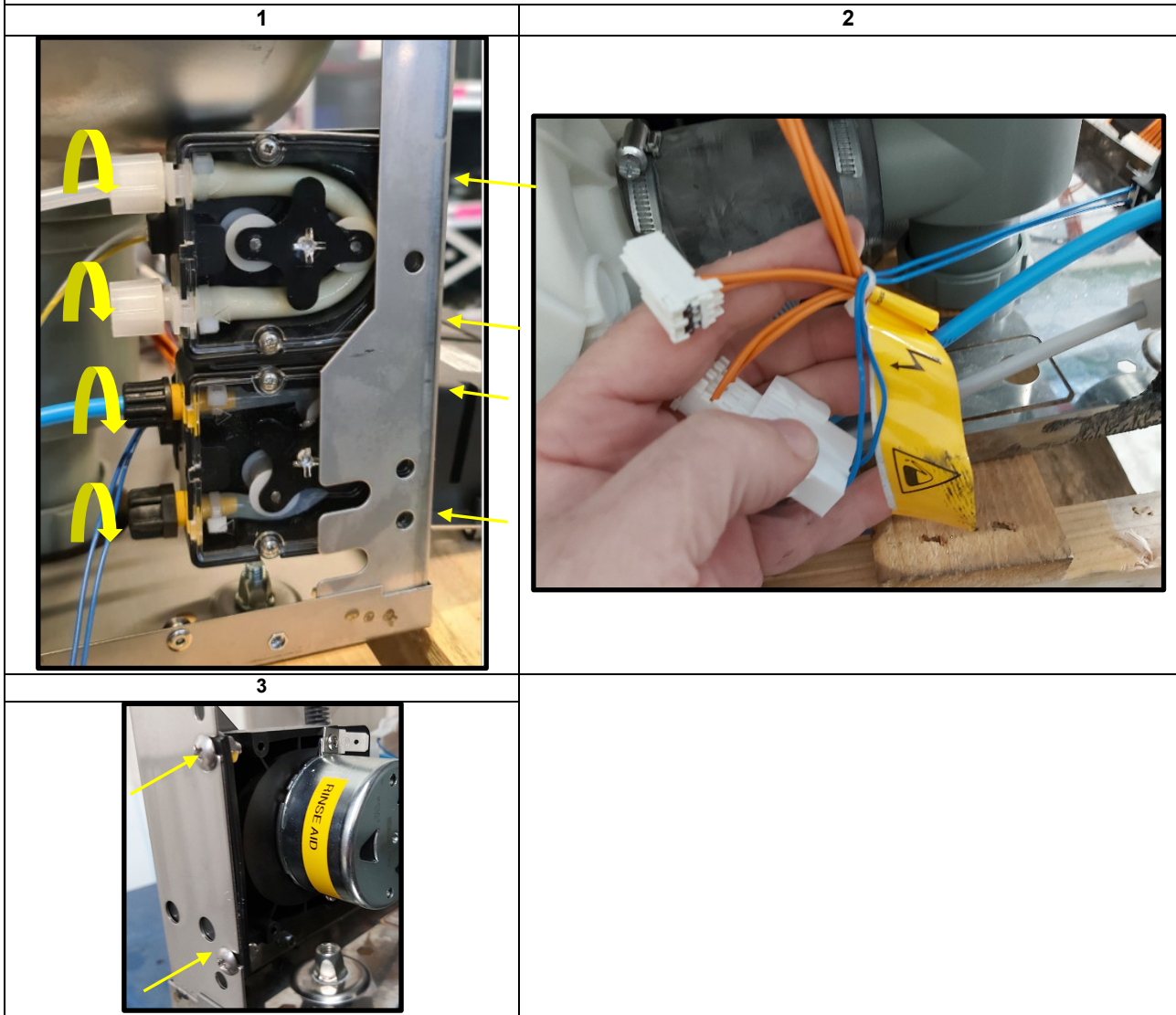

## 6.3.19 Tank Pressure switch C18 replacement

- 1) Following the instruction back access
- 2) Remove the wiring connector in the tank pressure switch (Fig.1)
- 3) Remove the hose (Fig.2)
- 4) Pull out the tank pressure switch (Fig.3)
- 5) Reinstall all components using the revers procedure, and use a tightening torque appropriate

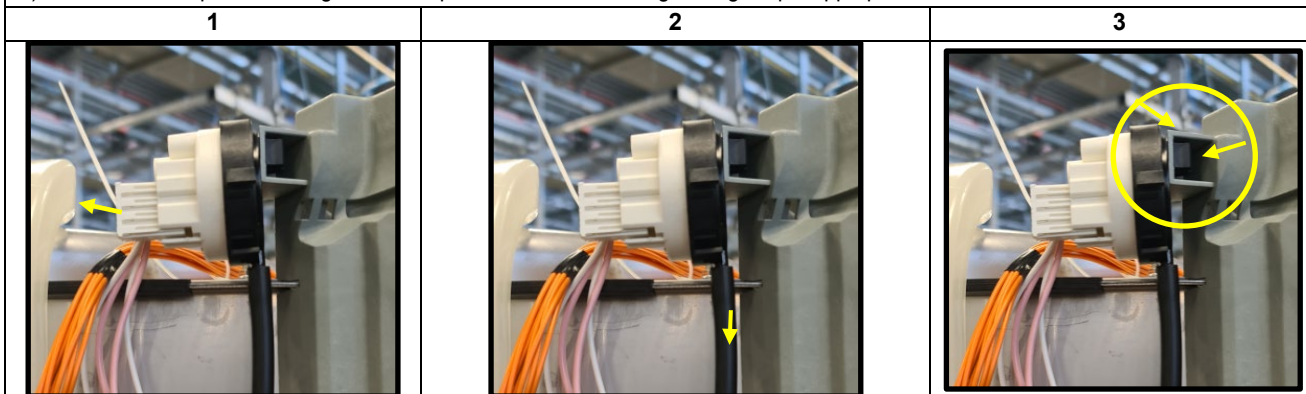

## 6.3.20 User interface C19 replacement

- 1) Open the door and unscrew the two screws under the user panel and pull the top panel out (Fig.1)
- 2) Remove the wiring connectors to the user interface and unscrew all the screws which fix the UI cover to the top panel (Fig. 2)
- 3) Open the housing of the UI (Fig.3)
- 4) Pull out the UI from the plastic housing (Fig.4)

Reinstall all components using the revers procedure, and use a tightening torque appropriate

Set up the proper configuration parameters of the appliance according to the model/PNC.

Please, refer to the Program list and Configuration parameters manual available on website <https://www.electroluxprofessional.com> and <https://webgate.electroluxprofessional.com>.

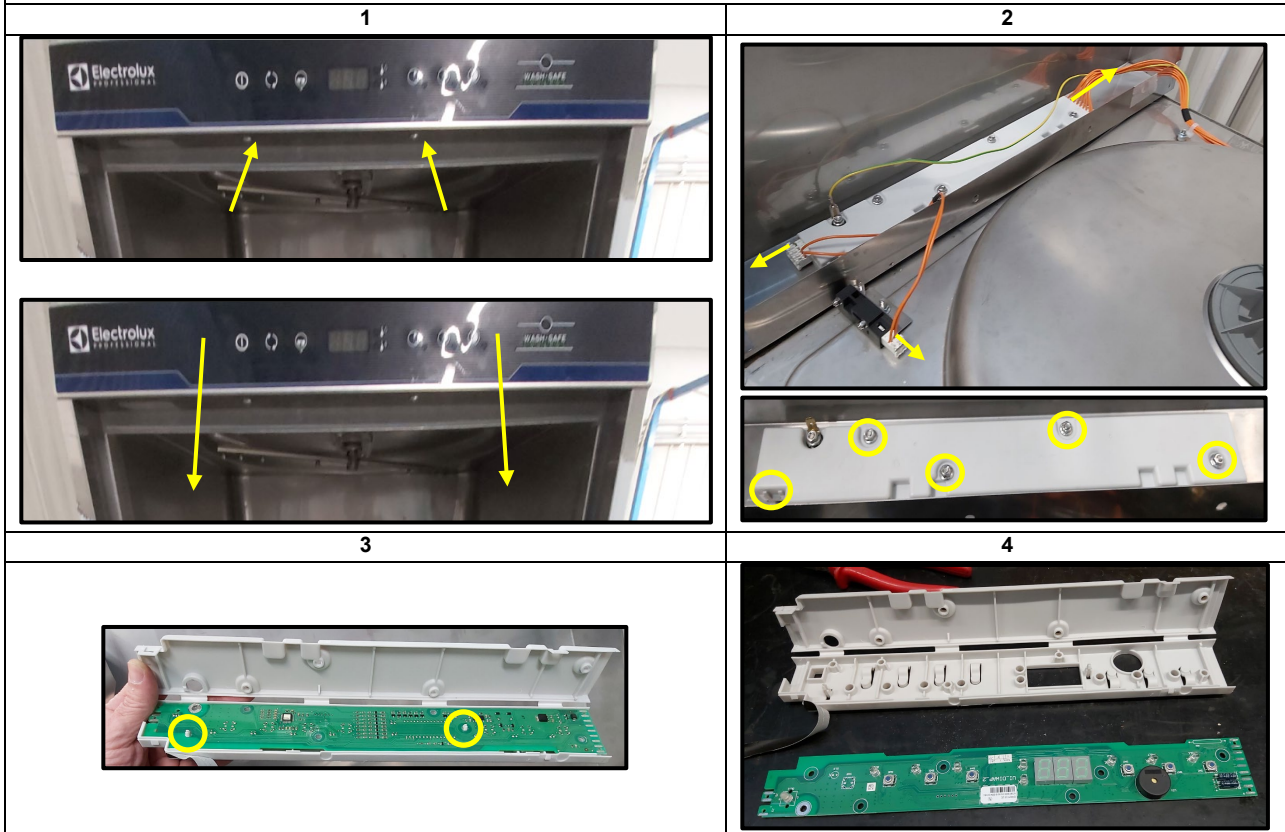

## 6.3.21 Door Switch C20 replacement

- 1) Following the instruction paragraph 6.3.3 (access to front components)
- 2) Remove the wiring (Fig.1)
- 3) Remove the bolt (Fig.2)
- 4) Reinstall all components using the revers procedure

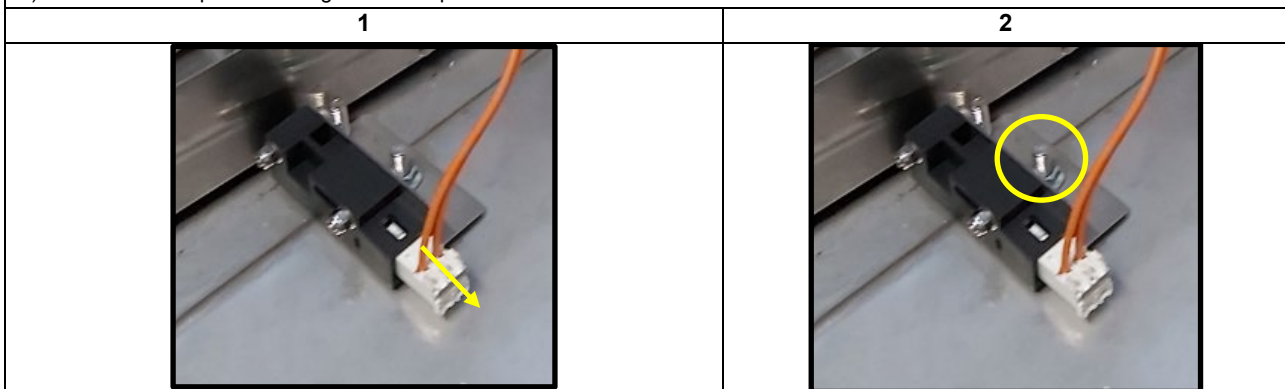

# 7 RELATED DOCUMENTS

## 7.1 EXPLODED VIEW

Please refer to the Spare Parts Catalogue of the appliance available on website: <https://www.electroluxprofessional.com> and <https://webgate.electroluxprofessional.com>

## 7.2 ELECTRICAL WIRING DIAGRAM

Please refer to the Electric Wiring Diagram of the appliance available on website: <https://www.electroluxprofessional.com> and <https://webgate.electroluxprofessional.com>

## 7.3 PLUMBING CIRCUITS DIAGRAMS

### 7.3.1 Undercounter with pressure boiler without drain pump

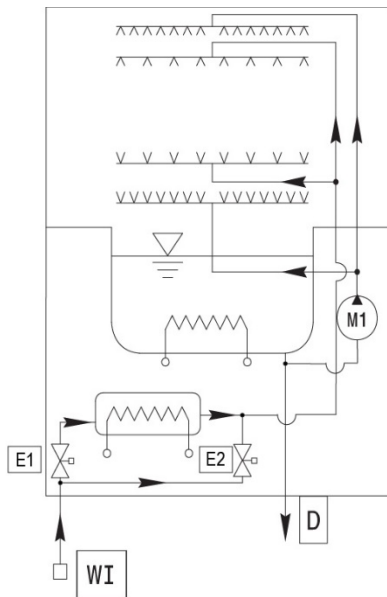

- E1: Filling Valve
- E2: Cold rinse valve
- M1: Wash Pump
- WI: Water inlet
- D: Drain

### 7.3.2 Undercounter with pressure boiler and drain pump

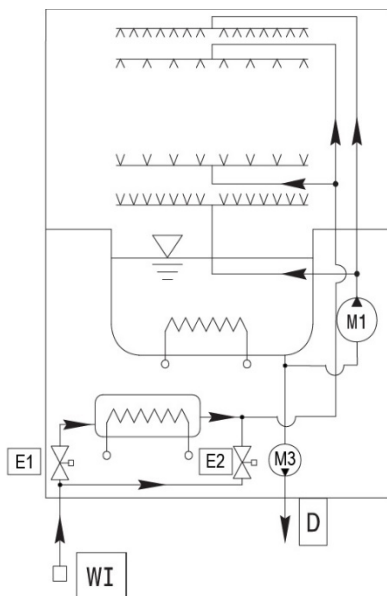

- E1: Filling Valve
- E2: Cold rinse valve
- M1: Wash Pump
- M3: Drain pump
- WI: water inlet
- D: Drain

### 7.3.3 Undercounter with atmospheric boiler

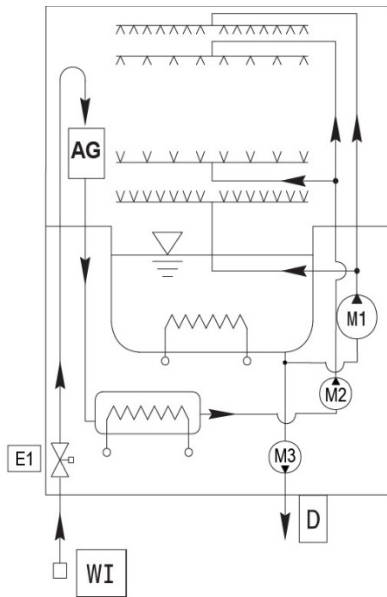

- E1: Filling valve
- AG: Airgap
- M1: Wash pump
- M2: Rinse pump
- M3: Drain pump
- WI: Water inlet
- D: Drain

## 7.4 PROGRAMMING PARAMETERS

In case of User interface replacement the Service Technician has to set up the proper configuration parameters of the appliance according to the model/PNC.

Please, refer to the Programming parameters manual available on website <https://www.electroluxprofessional.com> and <https://webgate.electroluxprofessional.com>.

Electrolux Professional SpA  
Viale Treviso, 15  
33170 Pordenone, ITALY  
Fax (+39) 0434 380 201  
: <https://www.electroluxprofessional.com>  
<https://webgate.electroluxprofessional.com>

---